

# Standards & Practices of Plastics Molders

## Guidelines for Molders and Their Customers

1998 edition

### INCLUDES

Commercial and Administrative Practices

Engineering and Technical Guidelines

Keys to Successful Design of Plastic Molded Parts

Molding Tolerances for 27 Plastic Resins

Reference Publications



the society of the plastics industry

Delivering business solutions for today's plastics industry.

sponsored by the SPI Molders Division

# **Standards & Practices of Plastics Molders**

## **Guidelines for Molders and Their Customers**

**Including:**

**Commercial and Administrative Practices  
Molding Guidelines  
Glossary of Terms  
Reference Publications**

---

## **Molders Division**

---



©Copyright 1965, 1967, 1978, 1988, 1991, 1993, 1998  
The Society of the Plastics Industry, Inc.  
1801 K Street, N.W., Suite 600K  
Washington, DC 20006-1301

## **Acknowledgment**

This *Guidelines for Plastics Molders* revision was commissioned and released by the Molders Division of The Society of the Plastics Industry, Inc. and produced in cooperation with the Manufacturing Resource and Productivity Center of Ferris State University. We wish to acknowledge the following contributions to this publication:

Editors: Eugene M. Whitmore, P.E., Assistant Professor  
Plastics Engineering Technology  
College of Technology  
Ferris State University

and

The Society of the Plastics Industry, Inc.  
Standards & Practices Review Committee

Illustrators: Karen Becker, Student  
and  
Frank Licht, Student  
Technical Illustration  
College of Technology  
Ferris State University

Compiled by: Manufacturing Resource and Productivity  
Center Staff:

Beckie DeYoung, Program Director  
Technology Transfer

Charlene Seaman, Project Assistant

# Standards & Practices of Plastics Molders

## Contents

### Contents

	Page
<b>Commercial and Administrative Practices of Plastics Molders</b>	
<b>Introduction</b>	1
<b>Contractual Obligations</b>	2
Quotations; Acceptance of Orders; Returns, Allowances, Cancellations, and Errors; Payment; Taxes; Consigned or Customer-Designed Tooling	
<b>Production and Handling of Tooling</b>	3
Selection of Types of Molds; Mold Maintenance, Repair and/or Replacement; Molds on Consignment; Mold Drawings; Mold Usage; Mold Storage; Mold Removal; Amortization and Insurance	
<b>Charges and Costs</b>	4
Periodic Review of Charges; Material, Labor and Burden Costs; Quality Requirements; Quantity Requirements; Other Factors	
<b>Inserts, Component Parts and Materials</b>	4
Supplied by Molder; Supplied by Customer; The Material Specification	
<b>Packing and Shipping</b>	5
Packing; Shipping Tolerances; Shipping Schedules; Damaged Shipments	
<b>Limitations on Inspection</b>	6
Prints and Approved Samples; Tolerances; Inspection; Statistical Quality Standards; Color; Gauges	
<b>Claims for Defects</b>	7
Basic Duty; Limitations; Claims for Freight	
<b>Patents</b>	7
<b>Product Design and Development</b>	7
<b>Objective: To Encourage Resource Recovery/Recycling</b>	7
<b>Engineering and Technical Guidelines of Plastics Custom Molders</b>	
<b>Introduction</b>	9
<b>General Information</b>	10
Our Objective Is; Scope; Sources; Comments	

### Engineering and Technical Guidelines of Plastics Custom Molders *(continued)*

<b>Keys to Successful Design of Plastics Molded Parts</b>	<b>11</b>
<b>Materials: Molding Guidelines</b>	<b>15</b>
Acrylonitrile Butadiene Styrene (ABS)	16
Acrylic	18
Alkyd (Thermoset)	20
Alkyd/Polyester (TS) (Glass Filled)	22
Cellulosics	24
Diallylphthalate (DAP)	26
Epoxy (EP)	28
High Density Polyethylene (HDPE)	30
Low Density Polyethylene (LDPE)	32
Melamine-Urea (MF-UF)	34
Melamine-Phenolic (MF-PF)	36
Polyamide (Nylon)(PA)	38
Polycarbonate (PC)	40
Polyetherimide (PEI)	42
Polyethylene-Terephthalate (PETE)	44
Phenol-Formaldehyde (PF)(Phenolic)(Fiber-filled)	46
Phenol-Formaldehyde (PF)(Phenolic)(General Purpose)	48
Phenol-Formaldehyde (PF)(Phenolic)(Glass Filled)	50
Polyoxymethylene (Acetal)(POM)	52
Polypropylene (PP)	54
Polyphenylene Ether (PPE)	56
Polyphenylene Oxide (PPO)	58
Polystyrene (PS)	60
Polyvinyl Chloride (PVC)(Vinyl)(Flexible)	62
Polyvinyl Chloride (PVC)(Vinyl)(Rigid)	64
Styrene-Acrylonitrile (SAN)	66
Thermoplastic Polyester (TPPE)	68

For materials not listed in this book, consult the manufacturer.

<b>Glossary of Terms</b>	<b>71</b>
--------------------------	-----------

<b>Reference Publications</b>	<b>95</b>
-------------------------------	-----------

General Information; Materials; Quality Control and Testing;  
Product Design; Mold Design; Processing;  
Fabrication, Assembly, Painting, and Decorating;  
Publishers and Organizations

**THE SOCIETY OF THE PLASTICS INDUSTRY, INC.**

**Commercial & Administrative Practices  
of Plastics Molders**

---

**Introduction**

This Molded Parts Buyers Guide has been prepared by the Molders Division of The Society of the Plastics Industry, Inc. It contains the important points that purchasers traditionally have considered in specifying and purchasing molded plastics parts.

As in every major fabricating industry, various commercial and administrative practices have developed over the years that play an important role in the conduct of day-to-day business. These arrangements, generally expressed in the proposal, acknowledgment and contract forms of the individual molding companies, have been viewed as constituting "customs of the trade." This informative manual is designed to identify and explain these customs.

The information in this manual has been prepared by the Molders Division of The Society of the Plastics Industry as a service to the industry. The trade customs outlined herein reflect the historic and customary practices prevailing in the plastics molding industry as of 1990, based on surveys of industry members. Contract forms and terms of individual molders will vary. This manual is offered in good faith and is believed to be accurate at the time of its preparation, but is offered **WITHOUT WARRANTY OF ANY KIND, EITHER EXPRESS OR IMPLIED**. SPI and its members accept no responsibility for any loss or damage arising from its use. SPI does not endorse the proprietary products or processes of any manufacturer.

*Note: The trade customs outlined herein reflect the historic and customary practices prevailing in the plastics molding industry based on a 1990 survey of industry members. Contract forms of individual molders may vary in some details.*

### Contractual Obligations

Each molder sells products and services on individual terms and conditions.

#### *Quotations*

Because of the molder's inability to predict changes in material costs or plant energy costs, a quotation generally has not been considered firm for more than 30 days (although, at times, molders have reserved the right to refuse acceptance of the quote even within the 30-day period). Some quotations state "subject to material price changes." Normally, the quotation will include the building of molds and tools and the production of molded parts based on prints and specifications available at the time of estimating. Some quotations also state, "subject to final agreement on specifications."

#### *Acceptance of Orders*

The quotation signed by an authorized representative of the molder, and the purchase order from the customer, are sufficient to constitute the entire contract providing it includes final agreement on specifications. Where there is any conflict between the quotation and the purchase order, the terms must be reconciled between the parties. Additions, deletions, modifications, suspensions or cancellations of a contract are not binding unless accepted by both parties, preferably in writing.

#### *Returns, Allowances, Cancellations, and Errors*

Molded parts usually are not returned for credit or replacement unless authorization to do so has been given by the molder in writing, and notification has been given of the intent to return within 10 days of receipt of the parts. Cancellations of any ordered tools or parts can be subject to cancellation charges to reimburse the molder for any expenses incurred

prior to the cancellation request. Clerical errors are subject to correction whether they favor the molder or the customer.

#### *Payment*

Payment terms usually are net and shipments F.O.B. the plant in which the parts are molded. Molds and tools typically remain in the molder's possession and terms include final payment of account before they are removed. Special terms usually will be negotiated for the introduction of new products or the building of molds, including advance and/or progress pay payments. When a molder builds a new mold for a customer, it is usual practice for the mold to be paid for in full, which constitutes approval, prior to the shipment of production quantities produced from the tooling. Also, prior to initiating engineering changes, payment for the original amount should be paid.

#### *Taxes*

Due to the wide variety of taxing bodies and various regulations, it is not practical to expect the molder to include taxes in all transactions. It generally has been understood that sales or use taxes, excise taxes on transportation, property taxes, and other direct taxes are the purchaser's responsibility, whether such taxes are federal, state or local. Where applicable in certain states and the product is for resale, the customer has supplied the molder with the appropriate number of the customer's retail merchants certificates.

#### *Consigned or Customer-Designed Tooling*

Where the molder uses customer-consigned or customer-designed tooling, the molder should consider seeking an indemnification and hold harmless agreement from the customer for claims arising from product failure (other than for claims arising from the molder's failure to meet the customer's specifications).

### Production and Handling of Tooling

#### *Selections of Types of Molds*

Molded parts can be produced by more than one type of mold and by various types of mold design. It is important that mold requirements and expected performance be agreed upon prior to acceptance of the order. Unless the customer has requested otherwise, the molder has exercised the right to determine the type of mold and details of mold design. Size and type of molding press most suitable for producing acceptable parts traditionally have been determined by the molder to assure production in the most economical manner.

#### *Mold Maintenance, Repair and/or Replacement*

Tooling purchased from a custom molder generally has been kept in a satisfactory condition and retained for the normal life of the mold. The normal life of the mold usually is considered as terminated when the customer no longer accepts the parts produced from the mold because of defects caused by mold wear, that no longer can be reasonably maintained. At that time, quotations are submitted by the molder covering (1) the cost of reworking the tooling or of replacing part or all of the mold as needed, or (2) the additional cost of secondary operations. Upon receipt of notice from the molder of the inability of the mold to hold tolerance due to wear as described, if the customer does not authorize mold repair or replacement and still requires production of parts from the mold, then the customer generally has assumed responsibility, in writing, for defective and/or reworked substandard product. Normal mold wear is a result of the quantity produced if production requirements significantly exceed the original estimates, which served as the basis for mold design and construction. It also should be noted that in the case of low volume production, frequent setup and

start-ups can contribute to abnormal tool wear. Molders typically have not been responsible for major mold repairs or replacement. Damage during transport is not the responsibility of the molder, but must be handled as a freight damage claim to the carrier.

#### *Molds on Consignment*

When a mold has been furnished by the customer and the molder was not involved in original design or construction, the molder has not assumed responsibility of the design and construction aspects or mold performance and/or product specifications unless specifically agreed upon, through tool capability studies and/or production experience.

#### *Mold Drawings*

It is not the practice of custom molders to furnish mold or tooling prints unless specifically agreed to in advance.

#### *Mold Usage*

A mold purchased by a particular customer or furnished by the customer is not used to produce parts for anyone else without the written consent of the original purchaser or registered owner of the tooling.

#### *Mold Storage*

Molds usually are stored without charge to the customer as long as the mold is active. However, after a two-year period of no production, the mold is ordinarily considered inactive. At that time, it is customary to request in writing instruction about the disposition of the mold from the customer. If the customer wishes the molder to continue possession of the inactive mold, storage charges may be applicable.



### *Mold Removal*

The molder has considerable engineering and development investment in a customer's mold by the time it is in production. For this reason, it has been customary for the custom molder to retain tools, molds and equipment which the molder has built or contracted to build. If the molds are removed from the molder's possession within one normal production year, it is normal for the molder to receive a removal fee to recover engineering costs. This should be contained in the molder's terms and conditions of sale.

### *Amortization and Insurance*

It is not customary to amortize molds, as the molder's investment in machinery is extremely heavy. It is not a common practice for the molder to carry any liability, fire or other insurance on molds, as this has been the customer's responsibility.

## **Charges and Costs**

### *Periodic Review of Charges*

It is customary to review the pricing structure of production periodically depending on cost. Such review has taken into account the factors entering into the structure.

### *Material, Labor and Burden Costs*

It is generally accepted that changes in the cost of raw materials, energy and labor may justify adjustment of selling prices by the molder.

### *Quality Requirements*

Generally, the custom molder will quote to the quality specified by the customer. Should the specification

have different interpretations, or should they change, the molder reserves the right to negotiate a new price. When a mold, through normal wear, can no longer be economically maintained and produces unacceptable quality, or requires the molder to perform additional secondary operations, it usually becomes the responsibility of the customer to decide whether to pay the added costs for maintenance for these secondary operations, or to pay for the mold refurbishment or replacement, whichever is necessary to return the mold to quality capable production.

### *Quantity Requirements*

Plastics part quotations ordinarily are made on the basis of continuous operations for the quantity specified for every delivery release, and shipped as produced. Change in scheduled deliveries or production interruptions by the customer usually have resulted in higher production costs for the molder, which may affect the original quotations.

### *Other Factors*

Changes in other factors that may result in increased costs are additional color change charges, out-of-balance parts from a family mold, changes in removable mold inserts and additional mold set-up charges. Where these charges are included in the piece part price and are not invoiced separately, and where changes in the customer's requirements occur, price revisions may be required.

## **Inserts, Component Parts and Materials**

### *Supplied by Molder*

When the custom molder has purchased the inserts, component parts, and/or material for the molded

part, the molder generally has included their cost, handling and inspection charges in the selling price. The molder traditionally assumes the responsibility for the quality of inserts, component parts, and material as specified by the customer. If it becomes necessary for the molder to purchase materials, inserts, packaging, etc., beyond the quantity required to fill an order, both parties need to agree in writing on the responsibility.

### *Supplied by Customer*

When the customer furnishes the inserts, component parts, and/or molding material for a molded part, the molder normally has added a handling charge to cover the cost of an incoming inspection. Unless otherwise agreed upon, this inspection has been limited to a determination that the molding material will mold properly and that component parts and/or inserts will allow for good assembly, and will not damage the mold. The molder has not accepted responsibility for the poor quality of the molded part when it is due to inferior inserts, component parts, or material. In addition, to cover in-plant spoilage and rejects, it has been the responsibility of the customer to furnish inserts, component parts, and/or material in an agreed upon quantity greater than the actual amount required to cover a specific order. The design of the insert has been subject to the approval of the molder. The customer is responsible for all materials obsoleted by an engineering change.

### *The Material Specification*

Often a custom molder is called upon to suggest a plastic material for a product application. Any material suggestion or use of a substitute material by the custom molder must be approved by the customer. Suitability and final approval of a suggested plastic

material for its intended purpose is the responsibility of the customer, who has a better understanding of the requirements of the component or product than the molder.

## **Packing and Shipping**

### *Packing*

Most custom molders will endeavor to provide a pack that will assure safe transportation of molded parts, and generally will describe the suggested type of packaging in their quotation. Should experience prove that a more expensive method of packing is required, a price revision is usually necessary.

### *Shipping Tolerances*

Unless indicated to the contrary, a quotation normally stipulates that the custom molder will have the right to ship up to 10 percent over or under the quantity ordered by the customer. If a lower shipping tolerance level is desired by the customer, the molder has rendered a quotation based upon revised requirements. In today's modern manufacturing environment utilizing JIT, FLOWMAN, KAN BAN, etc., exact quantities are critical.

### *Shipping Schedules*

Normally, the molder will ship each order or each release of an order in one complete shipment, and in a manner to take advantage of the most economical freight rates. Requests by the customer for orders to be shipped partially and/or in a more costly manner have put the financial responsibility for the added cost on the customer. Delaying a scheduled shipment for more than a reasonable length of time is subject to the approval of the molder.

### *Damaged Shipments*

When molded parts are broken or damaged while in transit from the molder's to the customer's plant, it traditionally has been considered the responsibility of the customer to file a claim with the carrier for the breakage or damage. Generally, additional quantities of parts to cover breakage and damage are ordered and included with the next scheduled production run of the same part.

### **Limitations on Inspection**

#### *Prints and Approved Samples*

Molded plastic parts have not been considered to be rejectable because of variation from print dimensions, if they are made to and are unchanged from approved samples with respect to dimension, finish and analysis or have failed with regard to function, or fitness for use, when the purchaser has specified or approved, material, design, and process. If sample molded plastics parts have not been approved, and conflicting models and prints have been submitted, the basis of acceptance has generally been agreed upon in writing.

#### *Tolerances*

Accuracy is subject to the commercial variations generally prevailing in the industry. Where very close tolerances, or particular dimensional accuracy are specified, permissible variations usually are agreed to and documented before mold work or production is begun. Process capability studies can be prepared to verify production tolerance capability of the process.

### *Inspection*

Process control is a generally accepted practice. Variable gauges can be provided in the tool quotation or quoted separately. Statistical process control coupled with in-process and final quality audits are common means for assuring quality on a continuing production basis. An agreement between the customer and the molder's Quality/Engineering group verifying critical quality characteristics is recommended. Where no agreement has been established, the molder generally advises the customer in writing of the quality standard described in Federal Specification 105. It must be emphasized that a joint agreement between the customer and the molder is necessary to assure production ready product delivery.

#### *Statistical Quality Standards*

Statistical process control is a tool of manufacturing and generally is available from molders. Documentary data, gauge certification and other related procedures can be provided. However, when general commercial quality standards without process control is adequate, a mutual agreement between the molder and the customer should be documented to cover potential product quality variables.

#### *Color*

The necessity for color match between several parts of an assembly has been basic in principle, but not always manageable in practice, particularly where these several parts are made from different materials, molded in different machines, and even come from different suppliers. Raw plastic material can be pre-colored by the material supplier or color blended with a color concentrate system by the molder.

With a customer-supplied color master, the molded parts should fall within the approved customer specifications.

### *Gauges*

It ordinarily has been the responsibility of the customer to provide any special gauges that may be needed.

## Claims for Defects

### *Basic Duty*

Custom molders have normally corrected, replaced, or issued credit for defective molded parts subject to specific limitations and conditions.

### *Limitations*

Claims for defective molded parts usually are not recognized unless made in writing within the time specified by the custom molder. Molded parts claimed to be defective generally are not returned for credit, correction or replacement unless authorized for return by the molder. However, authorized return of parts for inspection by the molder has not been construed by the molder as admission of a claim of defect. Claims for defective molded parts generally have not been recognized if the part has been assembled, machined, altered or finished in any way after delivery to the customer. The molder's liability is limited to the replacement of defective parts. The molder is not responsible for consequential damages.

### *Claims for Freight*

A molder generally ships product FOB the molding plant. Mode of product transportation usually is determined by the customer. In the case of a premium

transportation requirement, the responsibility for the premium cost is borne by the customer unless such charges have been accepted by the molder. Returned goods are not shipped to the molder without written authorization.

## Patents

Custom Molders traditionally have assumed no responsibility for the legality of the design of the customer's product, the design of the molded part as a component of that product, or parts produced to the customer's design and specification. In the event a molded part infringes, or is claimed to infringe, any letters patent or copyright, the customer has assumed the responsibility involved. Normally most quotation forms include clauses which explicitly detail the indemnification provisions.

## Product Design and Development

Custom molders who provide product design assistance or total product design services for the customer generally assign ownership of the design to the customer. Ownership of the design also transfers product responsibilities to the customer. Often design services by custom molders include tool development and production opportunity guarantees. Charges for design services are included in prototype and production tool costs.

## Objective: To Encourage Resource Recovery/Recycling

Original equipment manufacturers and their thermoplastic molded component suppliers are encouraged to consider the use of material abbreviations on their molded products. These abbreviations can be molded into a component sur-

# Standards & Practices of Plastics Molders

Commercial and  
Administrative Practices

face that would not affect product appearance. Material designations will identify materials for post-product-life resource recovery and recycling. The Molders Division encourages this practice. The Society of the Plastics Industry, Inc. has developed a resin identification code to facilitate recycling. The code assigns a number to six different resins and includes a seventh number for "Other." This number is featured inside a triangle of chasing arrows, with the resin abbreviation printed underneath, as shown below.

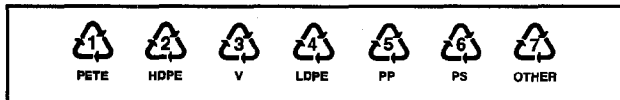

**THE SOCIETY OF THE PLASTICS INDUSTRY, INC.**

**Engineering and Technical Guidelines  
of Plastics Custom Molders**

---

**Introduction**

The preparation of the data and information on the following pages has been accomplished through the joint efforts of the Molders Division of The Society of the Plastics Industry membership body and the Manufacturing, Resource and Productivity Center personnel at Ferris State University, Big Rapids, Michigan.

It is the objective of this publication to provide a concise and relative guide for design engineers, purchasing agents, molders and customers in their mutual preparation of plastics part projects. The use of this guide will assist in the effective communication of the needs of the particular specialty areas involved in a project.

### General Information

#### *Our Objective Is:*

- To provide accessible and comprehensive guidelines for design applications and tolerance specifications on plastics materials currently manufactured.
- To be a guide in creating a part design consistent with good molding practices and comparable to plastics industry criteria.
- To be a guide in understanding parameters of plastics manufacturing, such as engineering services, quality, delivery, product design and cost necessary to maintain good molding practices.
- To be a guide in establishing a basis for quotation of costs for production and services that can be used for competitive comparisons.
- We anticipate that design engineers, purchasing agents, custom molders, and customers will find this information to be a valued reference.

#### *Scope*

It is the intention of these guidelines to identify those plastics materials commonly used by plastics molders using injection, compression and transfer molding processes and quantify specifications and tolerances consistent with good plastics industry molding practices.

#### *Sources*

The data compiled within these guidelines represents the results of a survey of plastics molders, plastics parts assemblers, and plastics materials suppliers to determine the values most consistent with good industry-wide molding practices.

#### *Comments*

The tolerance information contained within these guidelines is prepared as a reference for plastics molders and their customers and competitors. The ranges of acceptable specifications have been determined using the simplest of parts for reference. Complicated and non-uniform designs must be considered individually. Special usage features and unusual parts also may require singular treatment. Good quality raw materials, proper equipment and accepted production techniques are essential attributes to good molding practices. General tolerances may be spelled out for the total design drawing, but critical dimensions require special tolerance notations. Communication among engineers, designers, molders, and customers is essential during all stages of a project. Prior to finalizing contracts, meetings and conference telephone calls should be held frequently to ensure proper project progress.

### Keys to Successful Design of Plastics Molded Parts

#### THREADS

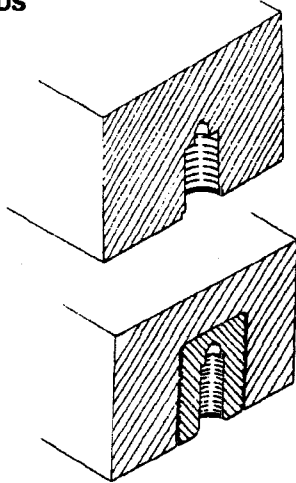

The larger sizes and coarse classes of "threads" are more acceptable for molded "threads." A minimum size of #6-32, class 1 or 2 and 60 percent (60%) "thread" depth should be considered. An acceptable design would require provisions for a chamfer or counter-bore (RECESS) of at least the depth of one "thread."

Inserts (METAL) are an acceptable means of providing "threads" in a plastic molded part and should be considered where fine pitch, small diameter and tight tolerances are required. Threaded metal inserts can be molded in place or inserted using a post-molding operation.

#### INSERTS MOLDED

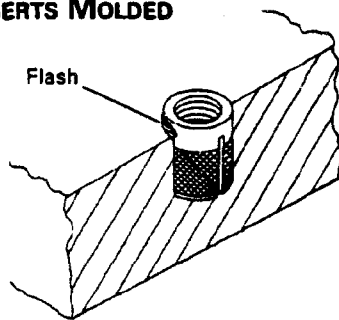

Flashing into or on to the "insert" may occur where inserts are molded in the part. Secondary operations may be required to remove the flash.

#### INSERT ASSEMBLIES

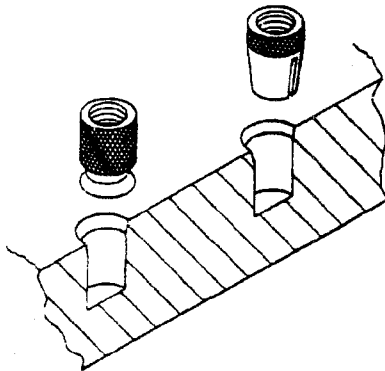

When plastics parts are designed for post-molding insertion of "inserts" a lead in chamfer or counter-bore should be provided, it must be specified whether the "inserts" are to be placed when the parts are warm or cool. For cool parts, the use of screw machine "insert" assemblies that expand into cool parts to lock the "insert" into place is acceptable. The use of ultrasonic devices to press the "inserts" into place is also an acceptable option. Assembling the "insert" at the machine when the part is warm or hot should be considered to eliminate the need for a secondary operation.



### FILLETS AND RADII

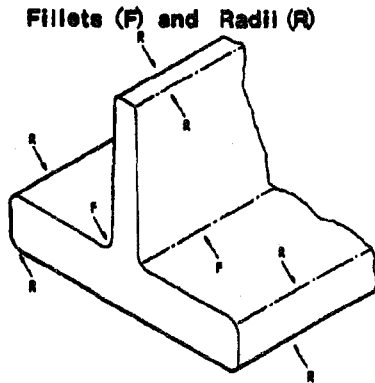

### DRAFT

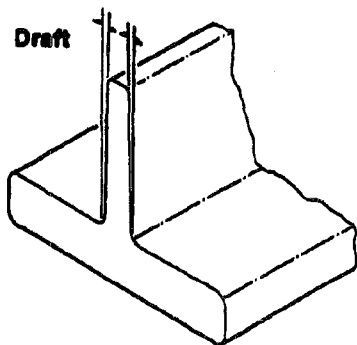

### CONCENTRICITY

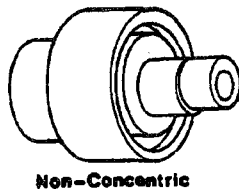
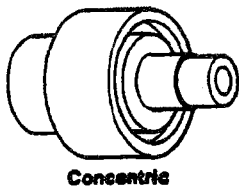

Sharp corners should be avoided where possible. Add maximum "radii" to strengthen the part, minimize strains, assist the flow of plastic in the mold, and strengthen mold members.

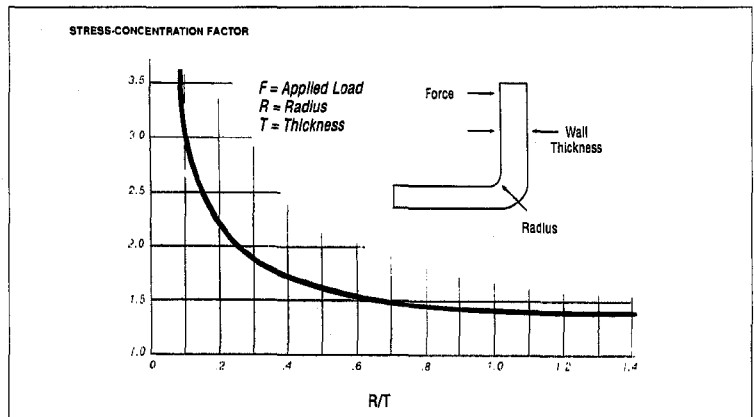

This curve gives an indication of the proper radius to be used for a given wall thickness. (Courtesy- SPI Plastics Engineering Handbook.)

Good design necessitates that "draft" or taper be provided on Draft plastics parts to facilitate production of acceptable molded parts and removal from the mold. Projections, holes, and cavities should be designed with "draft." A one degree "draft" angle is recommended for sections of one inch in length or less. Sections of greater than one inch in length should have a minimum 1/2 degree "draft" angle. Some materials or textured surfaces may require greater "draft."

The "concentricity"<sup>1</sup> of a part should allow for the maximum tolerance. The geometry of the part should help indicate the tolerances to be applied. A minimum tolerance of 0.005 inches FIM<sup>2</sup> per one inch of part diameter is appropriate. This minimum may vary depending on the material.

- Note: 1. Concentricity. The condition in which two (2) or more features in any combination have a common axis.  
2. FIM = Full Indicator Movement.

### OUT-OF-ROUND

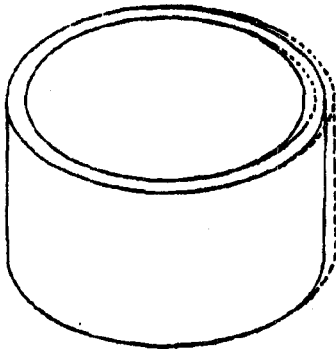

Parts that are round, such as shells, cups and rings, may distort and go "out-of-round." Part geometry, materials, gating methods and processing conditions are contributing factors. Expect 0.007 inches per one inch of diameter as an average "out-of-round" condition.

### GATES

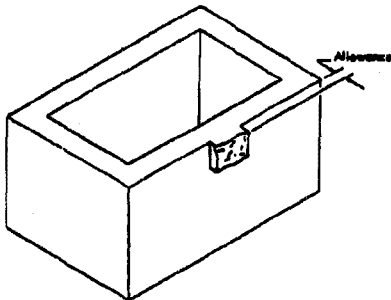

In most plastic molds, "gates" are provided to allow material to flow into the mold cavities. Removal of the "gate" protrusion or blemish from the final product may be required when "gates" are large or located in undesirable positions. Secondary operations may become costly, therefore consideration should be given to locating "gates" in more acceptable positions or using alternate "gate" designs. If removal of "gates" is required, the following allowance for protrusion or divot should be made before each type of removal operation:

BREAKING (break gate)	~	0.025 inches
CLIPPING (clip gate)	~	0.010 inches
MACHINING (machine gate)	~	0.005 inches

### MISMATCH

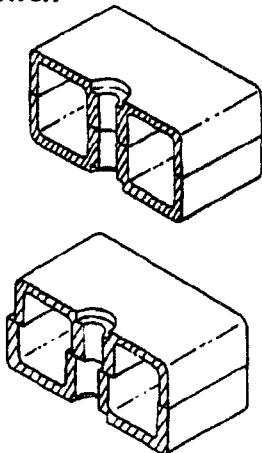

Be alert for assembled parts "mismatch," material dissimilarities, molding machine variations or different part sources are possible causes. Typically, a "tongue and groove" approach will hide most "mismatch." Good design practices allow for a .030 to .050 "beauty gap" to hide "mismatch" potential. For many parts, designed-in "mismatch" can be used to resolve potential appearance problems. Good practices for assembled parts design require extensive communication between product designers, mold designers, and the molder involved.

### WALL SECTIONS

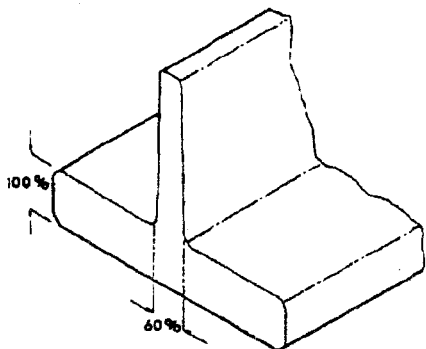

Heavy and non-uniform “sections” or “walls” may result in sinks and stress. For amorphous materials, the thickness of the ribs and adjoining “walls” should be approximately 70% of the main “wall” thickness to prevent sinks, weakened areas or blemishes. For crystalline materials, the thickness of the ribs and adjoining “walls” should be approximately 50% of the main “wall” thickness.

### FLATNESS AND WARPAGE

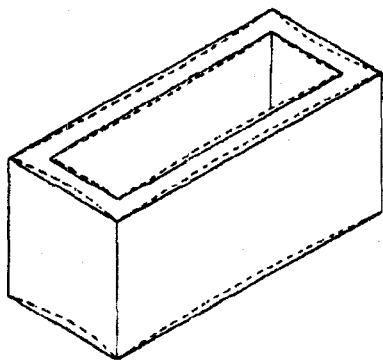

The designer of plastics parts should anticipate and allow for possible “warpage” in plastics parts. “Warpage,” distortion and shrinkage may vary depending on the material used, the geometry and size of the part, the mold design, and the processing conditions. Achieving successful part production requires open communication among the product designers, the mold designers and the molders. “Warpage” can be controlled by the use of cooling fixtures. However, good design and processing is the preferred method of achieving acceptable “warpage” control. Fixtures should not be used without due consideration for limitations and undesirable side-effects. “Flatness” requirements should be specified and tooling designed to assure the meeting of specifications. As with “warpage,” care should be taken before using fixtures to achieve the desired “flatness.”

**THE SOCIETY OF THE PLASTICS INDUSTRY, INC.**

**Engineering and Technical Guidelines  
of Plastics Custom Molders**

---

**Materials: Molding Guidelines**

*These are typical values but users are strongly urged to test their own products to assure that proper performance characteristics are met. Special features may necessitate consulting other appropriate standards.*

# Standards & Practices of Plastics Molders

**Material**  
Acrylonitrile Butadiene  
Styrene (ABS)

*Note:* The *Commercial* values shown below represent common production tolerances at the most economical level. The *Fine* values represent closer tolerances that can be held but at a greater cost. Any addition of fillers will compromise physical properties and alter dimensional stability. Please consult the manufacturer.

Drawing Code	Dimensions (Inches)	Plus or Minus in Thousands of an Inch					
		5	10	15	20	25	
A = Diameter (See note #1)	0.000						
	0.500						
	1.000						
	2.000						
	3.000						
	4.000						
	5.000						
	6.000						
	6.000 to 12.000 for each additional inch add (inches)	Comm. ±	Fine ±				
		0.003	0.002				
D = Bottom Wall	(See note #3)	0.004	0.002				
E = Side Wall	(See note #4)	0.003	0.002				
F = Hole Size Diameter (See note #1)	0.000 to 0.125	0.002	0.001				
	0.126 to 0.250	0.002	0.001				
	0.251 to 0.500	0.003	0.002				
	0.501 & over	0.004	0.002				
G = Hole Size Depth (See note #5)	0.000 to 0.250	0.003	0.002				
	0.251 to 0.500	0.004	0.002				
	0.501 to 1.000	0.005	0.003				
H = Corners, Ribs, Fillets	(See note #6)	0.027	0.017				
Flatness (See note #4)	0.000 to 3.000	0.015	0.010				
	3.001 to 6.000	0.030	0.020				
Thread Size (Class)	Internal	1	2				
	External	1	2				
Concentricity	(See note #4) (F.I.M.)	0.009	0.005				
Draft Allowance Per Side	(See note #5)	2.0°	1.0°				
Surface Finish	(See note #7)						
Color Stability	(See note #7)						

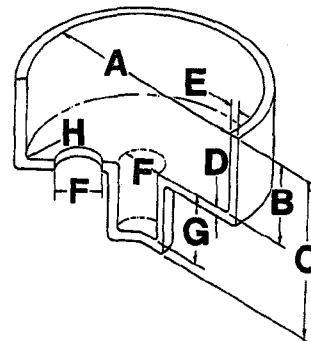

### REFERENCE NOTES

1. These tolerances do not include allowance for aging characteristics of material.
2. Tolerances are based on 0.125 inch wall section.
3. Parting line must be taken into consideration.
4. Part design should maintain a wall thickness as nearly constant as possible. Complete uniformity in this dimension is sometimes impossible to achieve. Walls of non-uniform thickness should be gradually blended from thick to thin.
5. Care must be taken that the ratio of the depth of a cored hole to its diameter does not reach a point that will result in excessive pin damage.
6. These values should be increased whenever compatible with desired design and good molding techniques.
7. Customer-Molder understanding is necessary prior to tooling.

# Standards & Practices of Plastics Molders

**Material**  
Acrylonitrile Butadiene  
Styrene (ABS)

*Note:* The *Commercial* values shown below represent common production tolerances at the most economical level. The *Fine* values represent closer tolerances that can be held but at a greater cost. Any addition of fillers will compromise physical properties and alter dimensional stability. Please consult the manufacturer.

Drawing Code	Dimensions (mm)	Plus or Minus in Thousands of an Millimeter										
		50	100	150	200	250	300	350	400	450	500	
A = Diameter (See note #1)	0											
	25											
	B = Depth (See note #3)	50										
		75										
	C = Height (See note #3)	100										
		125										
		150										
	150 to 300 for each additional 25 mm add (mm)	Comm. ±	Fine ±									
D = Bottom Wall	(See note #3)	0.105	0.050									
E = Side Wall	(See note #4)	0.055	0.075									
F = Hole Size Diameter (See note #1)	0.000 to 3.000	0.055	0.025									
	3.001 to 6.000	0.055	0.025									
	6.001 to 12.000	0.080	0.050									
	12.001 & over	0.105	0.050									
G = Hole Size Depth (See note #5)	0.000 to 6.000	0.080	0.050									
	6.001 to 12.000	0.105	0.050									
	12.001 to 25.000	0.130	0.075									
H = Corners, Ribs, Fillets	(See note #6)	0.690	0.430									
Flatness (See note #4)	0.000 to 75.000	0.385	0.250									
	75.001 to 150.000	0.765	0.505									
Thread Size (Class)	Internal	1	2									
	External	1	2									
Concentricity	(See note #4) (F.I.M.)	0.230	0.120									
Draft Allowance Per Side	(See note #5)	2.0°	1.0°									
Surface Finish	(See note #7)											
Color Stability	(See note #7)											

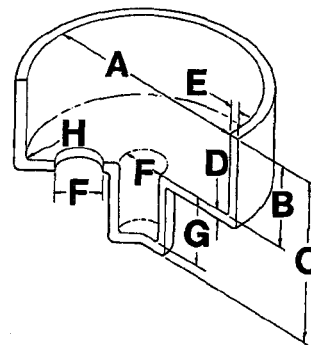

## REFERENCE NOTES

1. These tolerances do not include allowance for aging characteristics of material.
2. Tolerances are based on 3.175 mm wall section.
3. Parting line must be taken into consideration.
4. Part design should maintain a wall thickness as nearly constant as possible. Complete uniformity in this dimension is sometimes impossible to achieve. Walls of non-uniform thickness should be gradually blended from thick to thin.
5. Care must be taken that the ratio of the depth of a cored hole to its diameter does not reach a point that will result in excessive pin damage.
6. These values should be increased whenever compatible with desired design and good molding techniques.
7. Customer-Molder understanding is necessary prior to tooling.

# Standards & Practices of Plastics Molders

Material

Acrylic

*Note:* The *Commercial* values shown below represent common production tolerances at the most economical level. The *Fine* values represent closer tolerances that can be held but at a greater cost. Any addition of fillers will compromise physical properties and alter dimensional stability. Please consult the manufacturer.

Drawing Code	Dimensions (Inches)	Plus or Minus in Thousands of an Inch				
		5	10	15	20	25
A = Diameter (See note #1)	0.000					
	0.500					
	1.000					
	2.000					
	3.000					
	4.000					
B = Depth (See note #3)	5.000					
	6.000					
C = Height (See note #3)	6.000 to 12.000 for each additional inch add (inches)	Comm. ±	Fine ±			
		0.004	0.002			
D = Bottom Wall	(See note #9)	0.005	0.002			
E = Side Wall	(See note #2)	0.004	0.002			
F = Hole Size Diameter (See note #1)	0.000 to 0.125	0.003	0.001			
	0.126 to 0.250	0.003	0.002			
	0.251 to 0.500	0.004	0.002			
	0.501 & over	0.005	0.003			
G = Hole Size Depth (See note #5)	0.000 to 0.250	0.004	0.002			
	0.251 to 0.500	0.004	0.002			
	0.501 to 1.000	0.006	0.003			
H = Corners, Ribs, Fillets	(See note #6)	0.025	0.012			
Flatness (See note #4)	0.000 to 3.000	0.013	0.008			
	3.001 to 6.000	0.023	0.015			
Thread Size (Class)	Internal	1	2			
	External	1	2			
Concentricity	(See note #4) (F.I.M.)	0.010	0.006			
Draft Allowance Per Side	(See note #5)	1.5°	0.75°			
Surface Finish	(See note #8)					
Color Stability	(See note #7)					

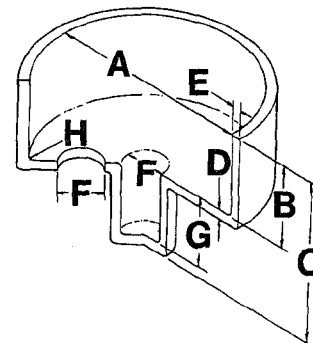

### REFERENCE NOTES

1. These tolerances do not include allowance for aging characteristics of material.
2. Wall thickness should be as uniform as possible.
3. Parting line must be taken into consideration.
4. Part design should maintain a wall thickness as nearly constant as possible. Complete uniformity in this dimension is sometimes impossible to achieve. Walls of non-uniform thickness should be gradually blended from thick to thin.
5. Care must be taken that the ratio of the depth of a cored hole to its diameter does not reach a point that will result in excessive pin damage.
6. Large radius is desirable to minimize part breakage.
7. Customer-Molder understanding is necessary prior to tooling.
8. Part surface finish is dependent on mold finish.
9. Based on nominal 0.125 inch wall.

# Standards & Practices of Plastics Molders

Material

Acrylic

*Note:* The *Commercial* values shown below represent common production tolerances at the most economical level. The *Fine* values represent *closer tolerances* that can be held but at a greater cost. Any addition of fillers will compromise physical properties and alter dimensional stability. Please consult the manufacturer.

Drawing Code	Dimensions (mm)	Plus or Minus in Thousands of an Millimeter									
		50	100	150	200	250	300	350	400	450	500
A = Diameter (See note #1)	0										
	25										
	50										
	75										
	100										
	125										
B = Depth (See note #3)	150										
	150 to 300 for each additional 25 mm add (mm)										
C = Height (See note #3)											
D = Bottom Wall	(See note #9)										
E = Side Wall	(See note #2)										
F = Hole Size Diameter (See note #1)	0.000 to 3.000										
	3.001 to 6.000										
	6.001 to 12.000										
	12.001 & over										
G = Hole Size Depth (See note #5)	0.000 to 6.000										
	6.001 to 12.000										
	12.001 to 25.000										
H = Corners, Ribs, Fillets	(See note #6)										
Flatness (See note #4)	0.000 to 75.000										
	75.001 to 150.000										
Thread Size (Class)	Internal										
	External										
Concentricity	(See note #4) (F.I.M.)										
Draft Allowance Per Side	(See note #5)										
Surface Finish	(See note #8)										
Color Stability	(See note #7)										

	Comm. ±	Fine ±
150 to 300 for each additional 25 mm add (mm)	0.105	0.050
D = Bottom Wall	0.130	0.050
E = Side Wall	0.105	0.050
F = Hole Size Diameter (See note #1)		
0.000 to 3.000	0.080	0.025
3.001 to 6.000	0.080	0.050
6.001 to 12.000	0.105	0.050
12.001 & over	0.130	0.075
G = Hole Size Depth (See note #5)		
0.000 to 6.000	0.105	0.050
6.001 to 12.000	0.105	0.050
12.001 to 25.000	0.155	0.075
H = Corners, Ribs, Fillets		
(See note #6)	0.635	0.300
Flatness (See note #4)		
0.000 to 75.000	0.330	0.200
75.001 to 150.000	0.585	0.380
Thread Size (Class)		
Internal	1	2
External	1	2
Concentricity		
(See note #4) (F.I.M.)	0.255	0.150
Draft Allowance Per Side		
(See note #5)	1.5°	0.75°
Surface Finish		
(See note #8)		
Color Stability		
(See note #7)		

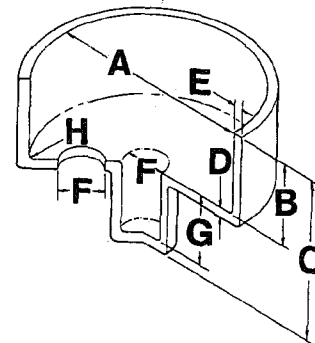

### REFERENCE NOTES

1. These tolerances do not include allowance for aging characteristics of material.
2. Wall thickness should be as uniform as possible.
3. Parting line must be taken into consideration.
4. Part design should maintain a wall thickness as nearly constant as possible. Complete uniformity in this dimension is sometimes impossible to achieve. Walls of non-uniform thickness should be gradually blended from thick to thin.
5. Care must be taken that the ratio of the depth of a cored hole to its diameter does not reach a point that will result in excessive pin damage.
6. Large radius is desirable to minimize part breakage.
7. Customer-Molder understanding is necessary prior to tooling.
8. Part surface finish is dependent on mold finish.
9. Based on nominal 3.175 mm wall.



# Standards & Practices of Plastics Molders

**Material**  
Alkyd  
(Thermoset)

*Note:* The *Commercial* values shown below represent common production tolerances at the most economical level. The *Fine* values represent closer tolerances that can be held but at a greater cost. Any addition of fillers will compromise physical properties and alter dimensional stability. Please consult the manufacturer.

Drawing Code	Dimensions (Inches)	Plus or Minus in Thousands of an Inch						
		5	10	15	20	25		
A = Diameter (See note #1)	0.000	Commercial	Fine					
	0.500							
	1.000							
	2.000							
	3.000							
	4.000							
	5.000							
B = Depth (See note #3)	6.000							
	6.000 to 12.000 for each additional inch add (inches)	Comm. ±	Fine ±					
D = Bottom Wall	(See note #3)	0.002	0.001					
E = Side Wall	(See note #4)	0.002	0.001					
F = Hole Size Diameter (See note #1)	0.000 to 0.125	0.002	0.001					
	0.126 to 0.250	0.002	0.002					
	0.251 to 0.500	0.002	0.002					
	0.501 & over	0.004	0.003					
G = Hole Size Depth (See note #5)	0.000 to 0.250	0.002	0.002					
	0.251 to 0.500	0.002	0.002					
	0.501 to 1.000	0.002	0.002					
H = Corners, Ribs, Fillets	(See note #6)	0.062	0.031					
Flatness (See note #4)	0.000 to 3.000	0.010	0.005					
	3.001 to 6.000	0.010	0.005					
Thread Size (Class)	Internal	1	2					
	External	1	2					
Concentricity	(See note #4) (F.I.M.)	0.005	0.005					
Draft Allowance Per Side	(See note #5)	1.0°	0.5°					
Surface Finish	(See note #7)							
Color Stability	(See note #7)							

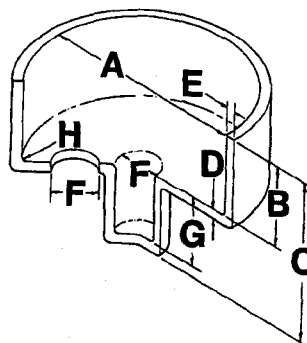

### REFERENCE NOTES

1. These tolerances do not include allowance for aging characteristics of material.
2. Tolerances are based on 0.125 inch wall section.
3. Parting line must be taken into consideration.
4. Part design should maintain a wall thickness as nearly constant as possible. Complete uniformity in this dimension is sometimes impossible to achieve. Walls of non-uniform thickness should be gradually blended from thick to thin.
5. Care must be taken that the ratio of the depth of a cored hole to its diameter does not reach a point that will result in excessive pin damage.
6. These values should be increased whenever compatible with desired design and good molding techniques.
7. Customer-Molder understanding is necessary prior to tooling.

# Standards & Practices of Plastics Molders

**Material**  
Alkyd  
(Thermoset)

*Note:* The *Commercial* values shown below represent common production tolerances at the most economical level. The *Fine* values represent closer tolerances that can be held but at a greater cost. Any addition of fillers will compromise physical properties and alter dimensional stability. Please consult the manufacturer.

Drawing Code	Dimensions (mm)	Plus or Minus in Thousands of an Millimeter									
		50	100	150	200	250	300	350	400	450	500
A = Diameter (See note #1)	0										
	25										
	50										
	75										
	100										
	125										
B = Depth (See note #3)	150										
	150 to 300 for each additional 25 mm add (mm)	Comm. ±	Fine ±								
D = Bottom Wall	(See note #3)	0.055	0.025								
E = Side Wall	(See note #4)	0.055	0.025								
F = Hole Size Diameter (See note #1)	0.000 to 3.000	0.055	0.025								
	3.001 to 6.000	0.055	0.050								
	6.001 to 12.000	0.055	0.050								
	12.001 & over	0.105	0.075								
G = Hole Size Depth (See note #5)	0.000 to 6.000	0.055	0.050								
	6.001 to 12.000	0.055	0.050								
	12.001 to 25.000	0.055	0.050								
H = Corners, Ribs, Fillets	(See note #6)	1.580	0.780								
Flatness (See note #4)	0.000 to 75.000	0.255	0.120								
	75.001 to 150.000	0.255	0.120								
Thread Size (Class)	Internal	1	2								
	External	1	2								
Concentricity	(See note #4) (F.I.M.)	0.130	0.120								
Draft Allowance Per Side	(See note #5)	1.0°	0.5°								
Surface Finish	(See note #7)										
Color Stability	(See note #7)										

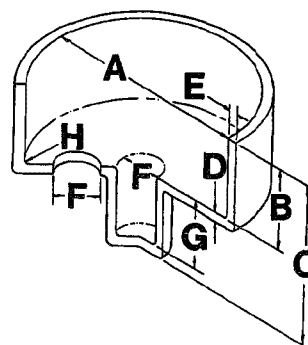

### REFERENCE NOTES

1. These tolerances do not include allowance for aging characteristics of material.
2. Tolerances are based on 3.175 mm wall section.
3. Parting line must be taken into consideration.
4. Part design should maintain a wall thickness as nearly constant as possible. Complete uniformity in this dimension is sometimes impossible to achieve. Walls of non-uniform thickness should be gradually blended from thick to thin.
5. Care must be taken that the ratio of the depth of a cored hole to its diameter does not reach a point that will result in excessive pin damage.
6. These values should be increased whenever compatible with desired design and good molding techniques.
7. Customer-Molder understanding is necessary prior to tooling.

# Standards & Practices of Plastics Molders

**Material**  
Alkyd/Polyester - TS  
(Glass filled)

*Note:* The *Commercial* values shown below represent common production tolerances at the most economical level. The *Fine* values represent closer tolerances that can be held but at a greater cost. Any addition of fillers will compromise physical properties and alter dimensional stability. Please consult the manufacturer.

Drawing Code	Dimensions (Inches)	Plus or Minus in Thousands of an Inch					
		5	10	15	20	25	
A = Diameter (See note #1)	0.000	Commercial Fine					
	0.500						
	1.000						
	2.000						
	3.000						
	4.000						
	5.000						
B = Depth (See note #3)	6.000						
	6.000 to 12.000 for each additional inch add (inches)	Comm. ± 0.001	Fine ± 0.001				
D = Bottom Wall	(See note #3)	0.003	0.002				
E = Side Wall	(See note #4)	0.001	0.001				
F = Hole Size Diameter	0.000 to 0.125	0.001	0.001				
	0.126 to 0.250	0.001	0.001				
	0.251 to 0.500	0.002	0.001				
	0.501 & over	0.002	0.001				
G = Hole Size Depth (See note #5)	0.000 to 0.250	0.001	0.001				
	0.251 to 0.500	0.001	0.001				
	0.501 to 1.000	0.002	0.001				
H = Corners, Ribs, Fillets	(See note #6)	0.062	0.031				
Flatness (See note #1)	0.000 to 3.000						
	3.001 to 6.000						
Thread Size (Class)	Internal	1	2				
	External	1	2				
Concentricity	(See note #4) (F.I.M.)						
Draft Allowance Per Side	(See note #5)	1.0°	0.5°				
Surface Finish	(See note #7)						
Color Stability	(See note #7)						

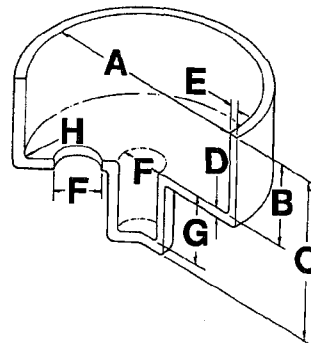

### REFERENCE NOTES

1. These tolerances can vary greatly, depending on method of molding and gate location.
2. Tolerances are based on 0.125 inch wall section.
3. Parting line must be taken into consideration.
4. Part design should maintain a wall thickness as nearly constant as possible. Complete uniformity in this dimension is sometimes impossible to achieve. Walls of non-uniform thickness should be gradually blended from thick to thin.
5. Care must be taken that the ratio of the depth of a cored hole to its diameter does not reach a point that will result in excessive pin damage.
6. These values should be increased whenever compatible with desired design and good molding techniques.
7. Customer-Molder understanding is necessary prior to tooling.

# Standards & Practices of Plastics Molders

**Material**  
Alkyd/Polyester - TS  
(Glass filled)

*Note:* The *Commercial* values shown below represent common production tolerances at the most economical level. The *Fine* values represent closer tolerances that can be held but at a greater cost. Any addition of fillers will compromise physical properties and alter dimensional stability. Please consult the manufacturer.

Drawing Code	Dimensions (mm)	Plus or Minus in Thousands of an Millimeter																				
		50	100	150	200	250	300	350	400	450	500											
	0																					
A = Diameter (See note #1)	25																					
B = Depth (See note #3)	50																					
	75																					
C = Height (See note #3)	100																					
	125																					
	150																					
	150 to 300 for each additional 25 mm add (mm)																					
		Comm. ±	Fine ±																			
D = Bottom Wall	(See note #3)	0.025	0.025																			
E = Side Wall	(See note #4)	0.025	0.025																			
F = Hole Size Diameter	0.000 to 3.000	0.025	0.025																			
	3.001 to 6.000	0.025	0.025																			
	6.001 to 12.000	0.050	0.025																			
	12.001 & over	0.050	0.025																			
G = Hole Size Depth (See note #5)	0.000 to 6.000	0.025	0.025																			
	6.001 to 12.000	0.025	0.025																			
	12.001 to 25.000	0.050	0.025																			
H = Corners, Ribs, Fillets	(See note #6)	1.580	0.780																			
Flatness (See note #1)	0.000 to 75.000																					
	75.001 to 150.000																					
Thread Size (Class)	Internal	1	2																			
	External	1	2																			
Concentricity	(See note #4) (F.I.M.)																					
Draft Allowance Per Side	(See note #5)	1.0°	0.5°																			
Surface Finish	(See note #7)																					
Color Stability	(See note #7)																					

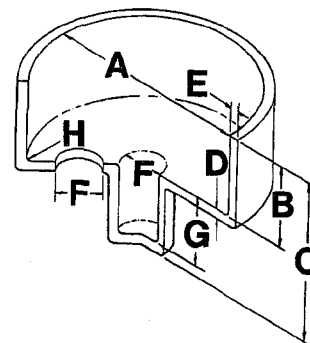

### REFERENCE NOTES

1. These tolerances can vary greatly, depending on method of molding and gate location.
2. Tolerances are based on 0.125 inch wall section.
3. Parting line must be taken into consideration.
4. Part design should maintain a wall thickness as nearly constant as possible. Complete uniformity in this dimension is sometimes impossible to achieve. Walls of non-uniform thickness should be gradually blended from thick to thin.
5. Care must be taken that the ratio of the depth of a cored hole to its diameter does not reach a point that will result in excessive pin damage.
6. These values should be increased whenever compatible with desired design and good molding techniques.
7. Customer-Molder understanding is necessary prior to tooling.

# Standards & Practices of Plastics Molders

**Material**  
Cellulosics

*Note:* The *Commercial* values shown below represent common production tolerances at the most economical level. The *Fine* values represent closer tolerances that can be held but at a greater cost. Any addition of fillers will compromise physical properties and alter dimensional stability. Please consult the manufacturer.

Drawing Code	Dimensions (Inches)	Plus or Minus in Thousands of an Inch				
		5	10	15	20	25
A = Diameter (See note #1)	0.000					
	0.500					
	1.000					
	2.000					
	3.000					
	4.000					
B = Depth (See note #3)	5.000					
C = Height (See note #3)	6.000					
	6.000 to 12.000 for each additional inch add (inches)	Comm. ±	Fine ±			
D = Bottom Wall	(See note #3)	0.004	0.002			
E = Side Wall	(See note #4)	0.004	0.002			
F = Hole Size Diameter (See note #1)	0.000 to 0.125	0.002	0.001			
	0.126 to 0.250	0.003	0.002			
	0.251 to 0.500	0.004	0.002			
	0.501 & over	0.005	0.003			
G = Hole Size Depth (See note #5)	0.000 to 0.250	0.004	0.002			
	0.251 to 0.500	0.005	0.002			
	0.501 to 1.000	0.006	0.003			
H = Corners, Ribs, Fillets	(See note #6)	0.030	0.015			
Flatness (See note #4)	0.000 to 3.000	0.025	0.015			
	3.001 to 6.000	0.050	0.030			
Thread Size (Class)	Internal	1 or 1B	2 or 2B			
	External	1 or 1A	2 or 2A			
Concentricity	(See note #4) (F.I.M.)	0.011	0.007			
Draft Allowance Per Side	(See note #5)	1.0°	0.5°			
Surface Finish	(See note #7)					
Color Stability	(See note #7)					

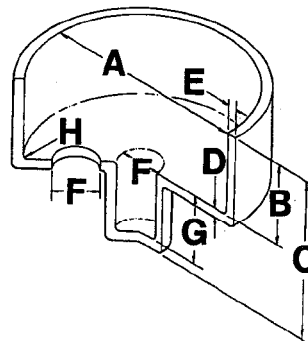

### REFERENCE NOTES

1. These tolerances do not include allowance for aging characteristics of material.
2. Tolerances are based on 0.125 inch wall section.
3. Parting line must be taken into consideration.
4. Part design should maintain a wall thickness as nearly constant as possible. Complete uniformity in this dimension is sometimes impossible to achieve. Walls of non-uniform thickness should be gradually blended from thick to thin.
5. Care must be taken that the ratio of the depth of a cored hole to its diameter does not reach a point that will result in excessive pin damage.
6. These values should be increased whenever compatible with desired design and good molding techniques.
7. Customer-Molder understanding is necessary prior to tooling.

# Standards & Practices of Plastics Molders

**Material**  
**Cellulosics**

*Note:* The *Commercial* values shown below represent common production tolerances at the most economical level. The *Fine* values represent closer tolerances that can be held but at a greater cost. Any addition of fillers will compromise physical properties and alter dimensional stability. Please consult the manufacturer.

Drawing Code	Dimensions (mm)	Plus or Minus in Thousands of an Millimeter												
		50	100	150	200	250	300	350	400	450	500			
A = Diameter (See note #1)  B = Depth (See note #3)  C = Height (See note #3)	0													
	25													
	50													
	75													
	100													
	125													
	150													
	150 to 300 for each additional 25 mm add (mm)	Comm. ±	Fine ±											
D = Bottom Wall	(See note #3)	0.105	0.050											
E = Side Wall	(See note #4)	0.105	0.050											
F = Hole Size Diameter (See note #1)	0.000 to 3.000	0.055	0.025											
	3.001 to 6.000	0.080	0.050											
	6.001 to 12.000	0.105	0.050											
	12.001 & over	0.130	0.075											
G = Hole Size Depth (See note #5)	0.000 to 6.000	0.105	0.050											
	6.001 to 12.000	0.130	0.050											
	12.001 to 25.000	0.155	0.075											
H = Corners, Ribs, Fillets	(See note #6)	0.765	0.380											
Flatness  (See note #4)	0.000 to 75.000	0.635	0.380											
	75.001 to 150.000	1.270	0.760											
Thread Size (Class)	Internal	1 or 1B	2 or 2B											
	External	1 or 1A	2 or 2A											
Concentricity	(See note #4) (F.I.M.)	0.280	0.175											
Draft Allowance Per Side	(See note #5)	1.0°	0.5°											
Surface Finish	(See note #7)													
Color Stability	(See note #7)													

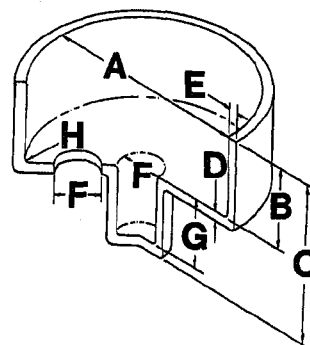

### REFERENCE NOTES

1. These tolerances do not include allowance for aging characteristics of material.
2. Tolerances are based on 3.175 mm wall section.
3. Parting line must be taken into consideration.
4. Part design should maintain a wall thickness as nearly constant as possible. Complete uniformity in this dimension is sometimes impossible to achieve. Walls of non-uniform thickness should be gradually blended from thick to thin.
5. Care must be taken that the ratio of the depth of a cored hole to its diameter does not reach a point that will result in excessive pin damage.
6. These values should be increased whenever compatible with desired design and good molding techniques.
7. Customer-Molder understanding is necessary prior to tooling.

# Standards & Practices of Plastics Molders

**Material**  
Diallylphthalate  
(DAP)

*Note:* The *Commercial* values shown below represent common production tolerances at the most economical level. The *Fine* values represent closer tolerances that can be held but at a greater cost. Any addition of fillers will compromise physical properties and alter dimensional stability. Please consult the manufacturer.

Drawing Code	Dimensions (Inches)	Plus or Minus in Thousands of an Inch				
		5	10	15	20	25
A = Diameter (See note #1)	0.000					
	0.500					
	1.000					
	2.000					
	3.000					
	4.000					
B = Depth (See note #3)	5.000					
	6.000					
C = Height (See note #3)	6.000 to 12.000 for each additional inch add (inches)	Comm. ±	Fine ±			
		0.002	0.001			
D = Bottom Wall	(See note #3)	0.005	0.003			
E = Side Wall	(See note #4)	0.003	0.002			
F = Hole Size Diameter (See note #1)	0.000 to 0.125	0.002	0.001			
	0.126 to 0.250	0.002	0.001			
	0.251 to 0.500	0.002	0.001			
	0.501 & over	0.003	0.002			
G = Hole Size Depth (See note #5)	0.000 to 0.250	0.002	0.001			
	0.251 to 0.500	0.003	0.002			
	0.501 to 1.000	0.005	0.003			
H = Corners, Ribs, Fillets	(See note #6)	0.062	0.031			
Flatness (See note #4)	0.000 to 3.000	0.010	0.005			
	3.001 to 6.000	0.012	0.008			
Thread Size (Class)	Internal	1	2			
	External	1	2			
Concentricity	(See note #4) (F.I.M.)	0.005	0.003			
Draft Allowance Per Side	(See note #5)	1.0°	0.5°			
Surface Finish	(See note #7)					
Color Stability	(See note #7)					

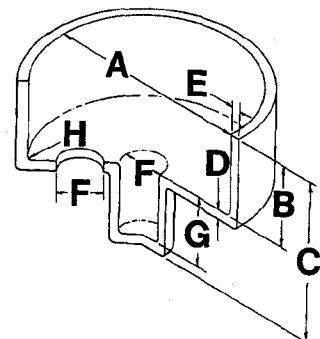

### REFERENCE NOTES

1. These tolerances do not include allowance for aging characteristics of material.
2. Tolerances are based on 0.125 inch wall section.
3. Parting line must be taken into consideration.
4. Part design should maintain a wall thickness as nearly constant as possible. Complete uniformity in this dimension is sometimes impossible to achieve. Walls of non-uniform thickness should be gradually blended from thick to thin.
5. Care must be taken that the ratio of the depth of a cored hole to its diameter does not reach a point that will result in excessive pin damage.
6. These values should be increased whenever compatible with desired design and good molding techniques.
7. Customer-Molder understanding is necessary prior to tooling.

# Standards & Practices of Plastics Molders

**Material**  
Diallylphthalate  
(DAP)

*Note:* The *Commercial* values shown below represent common production tolerances at the most economical level. The *Fine* values represent closer tolerances that can be held but at a greater cost. Any addition of fillers will compromise physical properties and alter dimensional stability. Please consult the manufacturer.

Drawing Code	Dimensions (mm)	Plus or Minus in Thousands of an Millimeter									
		50	100	150	200	250	300	350	400	450	500
	0										
A = Diameter (See note #1)	25										
B = Depth (See note #3)	50										
C = Height (See note #3)	75										
	100										
	125										
	150										
	150 to 300 for each additional 25 mm add (mm)	Comm. ±	Fine ±								
		0.055	0.025								
D = Bottom Wall	(See note #3)	0.130	0.075								
E = Side Wall	(See note #4)	0.080	0.050								
F = Hole Size Diameter (See note #1)	0.000 to 3.000	0.055	0.025								
	3.001 to 6.000	0.055	0.025								
	6.001 to 12.000	0.055	0.025								
	12.001 & over	0.080	0.050								
G = Hole Size Depth (See note #5)	0.000 to 6.000	0.055	0.025								
	6.001 to 12.000	0.080	0.050								
	12.001 to 25.000	0.130	0.075								
H = Corners, Ribs, Fillets	(See note #6)	1.580	0.780								
Flatness (See note #4)	0.000 to 75.000	0.255	0.120								
	75.001 to 150.000	0.305	0.200								
Thread Size (Class)	Internal	1	2								
	External	1	2								
Concentricity	(See note #4) (F.I.M.)	0.130	0.075								
Draft Allowance Per Side	(See note #5)	1.0°	0.5°								
Surface Finish	(See note #7)										
Color Stability	(See note #7)										

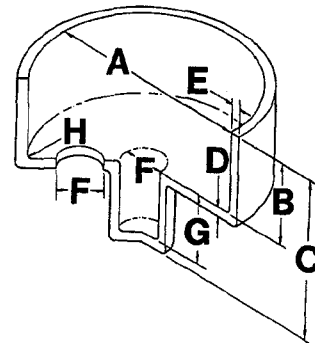

## REFERENCE NOTES

1. These tolerances do not include allowance for aging characteristics of material.
2. Tolerances are based on 3.175 mm wall section.
3. Parting line must be taken into consideration.
4. Part design should maintain a wall thickness as nearly constant as possible. Complete uniformity in this dimension is sometimes impossible to achieve. Walls of non-uniform thickness should be gradually blended from thick to thin.
5. Care must be taken that the ratio of the depth of a cored hole to its diameter does not reach a point that will result in excessive pin damage.
6. These values should be increased whenever compatible with desired design and good molding techniques.
7. Customer-Molder understanding is necessary prior to tooling.



# Standards & Practices of Plastics Molders

Material  
Epoxy  
(EP)

*Note:* The *Commercial* values shown below represent common production tolerances at the most economical level. The *Fine* values represent closer tolerances that can be held but at a greater cost. Any addition of fillers will compromise physical properties and alter dimensional stability. Please consult the manufacturer.

Drawing Code	Dimensions (Inches)	Plus or Minus in Thousands of an Inch				
		5	10	15	20	25
A = Diameter (See note #1)	0.000					
	0.500					
	1.000					
	2.000					
	3.000					
	4.000					
B = Depth (See note #3)	5.000					
	6.000					
C = Height (See note #3)	6.000 to 12.000 for each additional inch add (inches)	Comm. ±	Fine ±			
		0.002	0.001			
D = Bottom Wall	(See note #3)	0.002	0.001			
E = Side Wall	(See note #4)	0.002	0.001			
F = Hole Size Diameter (See note #1)	0.000 to 0.125	0.002	0.001			
	0.126 to 0.250	0.002	0.002			
	0.251 to 0.500	0.002	0.002			
	0.501 & over	0.004	0.003			
G = Hole Size Depth (See note #5)	0.000 to 0.250	0.002	0.002			
	0.251 to 0.500	0.002	0.002			
	0.501 to 1.000	0.002	0.002			
H = Corners, Ribs, Fillets	(See note #6)	0.062	0.031			
Flatness (See note #4)	0.000 to 3.000	0.010	0.010			
	3.001 to 6.000	0.015	0.010			
Thread Size (Class)	Internal	1	2			
	External	1	2			
Concentricity	(See note #4) (F.I.M.)	0.005	0.005			
Draft Allowance Per Side	(See note #5)	1.0°	0.5°			
Surface Finish	(See note #7)					
Color Stability	(See note #7)					

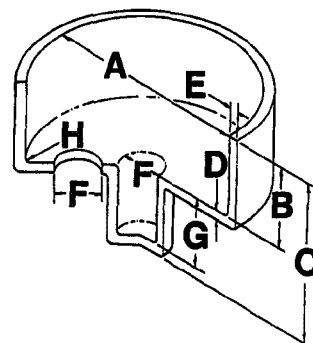

## REFERENCE NOTES

1. These tolerances do not include allowance for aging characteristics of material.
2. Tolerances are based on 0.125 inch wall section.
3. Parting line must be taken into consideration.
4. Part design should maintain a wall thickness as nearly constant as possible. Complete uniformity in this dimension is sometimes impossible to achieve. Walls of non-uniform thickness should be gradually blended from thick to thin.
5. Care must be taken that the ratio of the depth of a cored hole to its diameter does not reach a point that will result in excessive pin damage.
6. These values should be increased whenever compatible with desired design and good molding techniques.
7. Customer-Molder understanding is necessary prior to tooling.

# Standards & Practices of Plastics Molders

**Material**  
Epoxy  
(EP)

*Note:* The *Commercial* values shown below represent common production tolerances at the most economical level. The *Fine* values represent closer tolerances that can be held but at a greater cost. Any addition of fillers will compromise physical properties and alter dimensional stability. Please consult the manufacturer.

Drawing Code	Dimensions (mm)	Plus or Minus in Thousands of an Millimeter									
		50	100	150	200	250	300	350	400	450	500
A = Diameter (See note #1)	0										
	25										
	50										
	75										
	100										
	125										
	150										
	150 to 300 for each additional 25 mm add (mm)	Comm. ±	Fine ±								
D = Bottom Wall	(See note #3)	0.055	0.025								
E = Side Wall	(See note #4)	0.055	0.025								
F = Hole Size Diameter (See note #1)	0.000 to 3.000	0.055	0.025								
	3.001 to 6.000	0.055	0.050								
	6.001 to 12.000	0.055	0.050								
	12.001 & over	0.105	0.075								
G = Hole Size Depth (See note #5)	0.000 to 6.000	0.055	0.050								
	6.001 to 12.000	0.055	0.050								
	12.001 to 25.000	0.055	0.050								
H = Corners, Ribs, Fillets	(See note #6)	1.580	0.780								
Flatness (See note #4)	0.000 to 75.000	0.260	0.250								
	75.001 to 150.000	0.380	0.250								
Thread Size (Class)	Internal	1	2								
	External	1	2								
Concentricity	(See note #4) (F.I.M.)	0.130	0.120								
Draft Allowance Per Side	(See note #5)	1.0°	0.5°								
Surface Finish	(See note #7)										
Color Stability	(See note #7)										

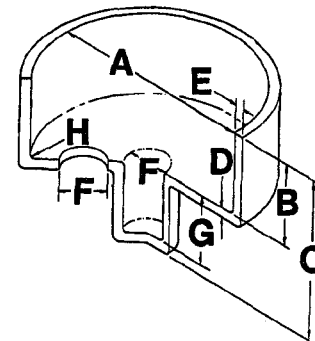

### REFERENCE NOTES

1. These tolerances do not include allowance for aging characteristics of material.
2. Tolerances are based on 3.175 mm wall section.
3. Parting line must be taken into consideration.
4. Part design should maintain a wall thickness as nearly constant as possible. Complete uniformity in this dimension is sometimes impossible to achieve. Walls of non-uniform thickness should be gradually blended from thick to thin.
5. Care must be taken that the ratio of the depth of a cored hole to its diameter does not reach a point that will result in excessive pin damage.
6. These values should be increased whenever compatible with desired design and good molding techniques.
7. Customer-Molder understanding is necessary prior to tooling.

# Standards & Practices of Plastics Molders

**Material**  
High Density Polyethylene  
(HDPE)

*Note:* The *Commercial* values shown below represent common production tolerances at the most economical level. The *Fine* values represent closer tolerances that can be held but at a greater cost. Any addition of fillers will compromise physical properties and alter dimensional stability. Please consult the manufacturer.

Drawing Code	Dimensions (Inches)	Plus or Minus in Thousands of an Inch				
		5	10	15	20	25
A = Diameter (See note #1)	0.000					
	0.500					
	1.000					
	2.000					
	3.000					
	4.000					
	5.000					
B = Depth (See note #3)	6.000					
	6.000 to 12.000 for each additional inch add (inches)	Comm. ±	Fine ±			
D = Bottom Wall	(See note #3)	0.006	0.004			
E = Side Wall	(See note #4)	0.006	0.004			
F = Hole Size Diameter (See note #1)	0.000 to 0.125	0.003	0.002			
	0.126 to 0.250	0.004	0.002			
	0.251 to 0.500	0.006	0.004			
	0.501 & over	0.008	0.005			
G = Hole Size Depth (See note #5)	0.000 to 0.250	0.005	0.003			
	0.251 to 0.500	0.007	0.004			
	0.501 to 1.000	0.009	0.006			
H = Corners, Ribs, Fillets	(See note #6)	0.025	0.010			
Flatness (See note #4)	0.000 to 3.000	0.023	0.015			
	3.001 to 6.000	0.037	0.022			
Thread Size (Class)	Internal	1	2			
	External	1	2			
Concentricity	(See note #4) (F.I.M.)	0.027	0.010			
Draft Allowance Per Side	(See note #5)	2.0°	0.75°			
Surface Finish	(See note #7)					
Color Stability	(See note #7)					

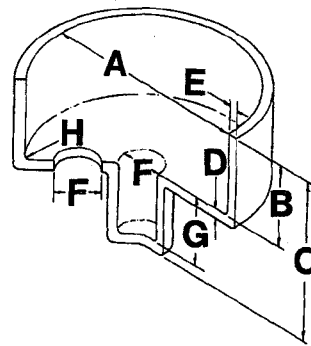

### REFERENCE NOTES

1. These tolerances do not include allowance for aging characteristics of material.
2. Tolerances are based on 0.125 inch wall section.
3. Parting line must be taken into consideration.
4. Part design should maintain a wall thickness as nearly constant as possible. Complete uniformity in this dimension is sometimes impossible to achieve. Walls of non-uniform thickness should be gradually blended from thick to thin.
5. Care must be taken that the ratio of the depth of a cored hole to its diameter does not reach a point that will result in excessive pin damage.
6. These values should be increased whenever compatible with desired design and good molding techniques.
7. Customer-Molder understanding is necessary prior to tooling.

# Standards & Practices of Plastics Molders

**Material**  
High Density Polyethylene  
(HDPE)

*Note:* The *Commercial* values shown below represent common production tolerances at the most economical level. The *Fine* values represent closer tolerances that can be held but at a greater cost. Any addition of fillers will compromise physical properties and alter dimensional stability. Please consult the manufacturer.

Drawing Code	Dimensions (mm)	Plus or Minus in Thousands of an Millimeter									
		50	100	150	200	250	300	350	400	450	500
A = Diameter (See note #1)	0										
	25										
	50										
	75										
	100										
	125										
B = Depth (See note #3)	150										
	150 to 300 for each additional 25 mm add (mm)	Comm. ±	Fine ±								
D = Bottom Wall	(See note #3)	0.155	0.100								
E = Side Wall	(See note #4)	0.155	0.100								
F = Hole Size Diameter (See note #1)	0.000 to 3.000	0.080	0.050								
	3.001 to 6.000	0.100	0.050								
	6.001 to 12.000	0.155	0.100								
	12.001 & over	0.205	0.125								
G = Hole Size Depth (See note #5)	0.000 to 6.000	0.125	0.075								
	6.001 to 12.000	0.180	0.100								
	12.001 to 25.000	0.230	0.155								
H = Corners, Ribs, Fillets	(See note #6)	0.635	0.250								
Flatness (See note #4)	0.000 to 75.000	0.585	0.380								
	75.001 to 150.000	0.940	0.555								
Thread Size (Class)	Internal	1	2								
	External	1	2								
Concentricity	(See note #4) (F.I.M.)	0.690	0.250								
Draft Allowance Per Side	(See note #5)	2.0°	0.75°								
Surface Finish	(See note #7)										
Color Stability	(See note #7)										

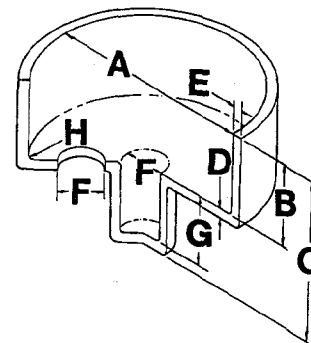

### REFERENCE NOTES

1. These tolerances do not include allowance for aging characteristics of material.
2. Tolerances are based on 3.175 mm wall section.
3. Parting line must be taken into consideration.
4. Part design should maintain a wall thickness as nearly constant as possible. Complete uniformity in this dimension is sometimes impossible to achieve. Walls of non-uniform thickness should be gradually blended from thick to thin.
5. Care must be taken that the ratio of the depth of a cored hole to its diameter does not reach a point that will result in excessive pin damage.
6. These values should be increased whenever compatible with desired design and good molding techniques.
7. Customer-Molder understanding is necessary prior to tooling.

# Standards & Practices of Plastics Molders

**Material**  
Low Density Polyethylene  
(LDPE)

*Note:* The *Commercial* values shown below represent common production tolerances at the most economical level. The *Fine* values represent closer tolerances that can be held but at a greater cost. Any addition of fillers will compromise physical properties and alter dimensional stability. Please consult the manufacturer.

Drawing Code	Dimensions (Inches)	Plus or Minus in Thousands of an Inch				
		5	10	15	20	25
A = Diameter (See note #1)	0.000					
	0.500					
	1.000					
	2.000					
	3.000					
	4.000					
	5.000					
B = Depth (See note #3)	6.000					
	6.000 to 12.000 for each additional inch add (inches)					
C = Height (See note #3)						
D = Bottom Wall	(See note #3)					
E = Side Wall	(See note #4)					
F = Hole Size Diameter (See note #1)	0.000 to 0.125					
	0.126 to 0.250					
	0.251 to 0.500					
	0.501 & over					
G = Hole Size Depth (See note #5)	0.000 to 0.250					
	0.251 to 0.500					
	0.501 to 1.000					
H = Corners, Ribs, Fillets	(See note #6)					
Flatness (See note #4)	0.000 to 3.000					
	3.001 to 6.000					
Thread Size (Class)	Internal					
	External					
Concentricity	(See note #4) (F.I.M.)					
Draft Allowance Per Side	(See note #5)					
Surface Finish	(See note #7)					
Color Stability	(See note #7)					

	Comm. ±	Fine ±
6.000 to 12.000 for each additional inch add (inches)	0.005	0.003
D = Bottom Wall (See note #3)	0.006	0.003
E = Side Wall (See note #4)	0.005	0.003
F = Hole Size Diameter (See note #1)		
0.000 to 0.125	0.004	0.002
0.126 to 0.250	0.005	0.003
0.251 to 0.500	0.006	0.004
0.501 & over	0.007	0.005
G = Hole Size Depth (See note #5)		
0.000 to 0.250	0.004	0.003
0.251 to 0.500	0.005	0.004
0.501 to 1.000	0.007	0.005
H = Corners, Ribs, Fillets (See note #6)	0.025	0.011
Flatness (See note #4)		
0.000 to 3.000	0.025	0.012
3.001 to 6.000	0.030	0.020
Thread Size (Class)		
Internal	1	2
External	1	2
Concentricity (See note #4) (F.I.M.)	0.011	0.007
Draft Allowance Per Side (See note #5)	2.0°	0.75°
Surface Finish (See note #7)		
Color Stability (See note #7)		

**REFERENCE NOTES**

1. These tolerances do not include allowance for aging characteristics of material.
2. Tolerances are based on 0.125 inch wall section.
3. Parting line must be taken into consideration.
4. Part design should maintain a wall thickness as nearly constant as possible. Complete uniformity in this dimension is sometimes impossible to achieve. Walls of non-uniform thickness should be gradually blended from thick to thin.
5. Care must be taken that the ratio of the depth of a cored hole to its diameter does not reach a point that will result in excessive pin damage.
6. These values should be increased whenever compatible with desired design and good molding techniques.
7. Customer-Molder understanding is necessary prior to tooling.

# Standards & Practices of Plastics Molders

**Material**  
Low Density Polyethylene  
(LDPE)

*Note:* The *Commercial* values shown below represent common production tolerances at the most economical level. The *Fine* values represent closer tolerances that can be held but at a greater cost. Any addition of fillers will compromise physical properties and alter dimensional stability. Please consult the manufacturer.

Drawing Code	Dimensions (mm)	Plus or Minus in Thousands of an Millimeter									
		50	100	150	200	250	300	350	400	450	500
A = Diameter (See note #1)	0										
	25										
	50										
	75										
	100										
	125										
B = Depth (See note #3)	150										
	150 to 300 for each additional 25 mm add (mm)	Comm. ±	Fine ±								
D = Bottom Wall	(See note #3)	0.130	0.075								
E = Side Wall	(See note #4)	0.155	0.075								
F = Hole Size Diameter (See note #1)	0.000 to 3.000	0.105	0.050								
	3.001 to 6.000	0.130	0.075								
	6.001 to 12.000	0.155	0.100								
	12.001 & over	0.180	0.125								
G = Hole Size Depth (See note #5)	0.000 to 6.000	0.105	0.075								
	6.001 to 12.000	0.130	0.100								
	12.001 to 25.000	0.180	0.125								
H = Corners, Ribs, Fillets	(See note #6)	0.635	0.275								
Flatness (See note #4)	0.000 to 75.000	0.635	0.305								
	75.001 to 150.000	0.765	0.505								
Thread Size (Class)	Internal	1	2								
	External	1	2								
Concentricity	(See note #4) (F.I.M.)	0.275	0.180								
Draft Allowance Per Side	(See note #5)	2.0°	0.75°								
Surface Finish	(See note #7)										
Color Stability	(See note #7)										

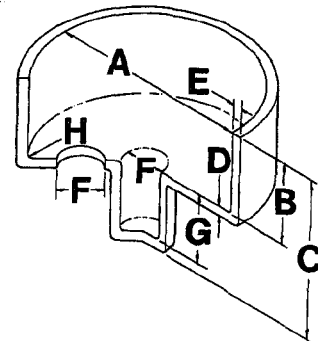

### REFERENCE NOTES

1. These tolerances do not include allowance for aging characteristics of material.
2. Tolerances are based on 3.175 mm wall section.
3. Parting line must be taken into consideration.
4. Part design should maintain a wall thickness as nearly constant as possible. Complete uniformity in this dimension is sometimes impossible to achieve. Walls of non-uniform thickness should be gradually blended from thick to thin.
5. Care must be taken that the ratio of the depth of a cored hole to its diameter does not reach a point that will result in excessive pin damage.
6. These values should be increased whenever compatible with desired design and good molding techniques.
7. Customer-Molder understanding is necessary prior to tooling.

# Standards & Practices of Plastics Molders

**Material**  
Melamine - Urea  
(MF-UF)

*Note:* The *Commercial* values shown below represent common production tolerances at the most economical level. The *Fine* values represent closer tolerances that can be held but at a greater cost. Any addition of fillers will compromise physical properties and alter dimensional stability. Please consult the manufacturer.

Drawing Code	Dimensions (Inches)	Plus or Minus in Thousands of an Inch				
		5	10	15	20	25
A = Diameter (See note #1)	0.000					
	0.500					
	1.000					
	2.000					
	3.000					
	4.000					
	5.000					
B = Depth (See note #3)	6.000					
	6.000 to 12.000 for each additional inch add (inches)	Comm. ±	Fine ±			
D = Bottom Wall	(See note #3)	0.005	0.003			
E = Side Wall	(See note #4)	0.004	0.002			
F = Hole Size Diameter (See note #1)	0.000 to 0.125	0.003	0.002			
	0.126 to 0.250	0.003	0.002			
	0.251 to 0.500	0.004	0.003			
	0.501 & over	0.005	0.004			
G = Hole Size Depth (See note #5)	0.000 to 0.250	0.003	0.002			
	0.251 to 0.500	0.004	0.002			
	0.501 to 1.000	0.005	0.002			
H = Corners, Ribs, Fillets	(See note #6)	0.030	0.015			
Flatness (See note #4)	0.000 to 3.000	0.012	0.008			
	3.001 to 6.000	0.018	0.013			
Thread Size (Class)	Internal	1	2			
	External	1	2			
Concentricity	(See note #4) (F.I.M.)	0.007	0.005			
Draft Allowance Per Side	(See note #5)	1.0°	0.5°			
Surface Finish	(See note #7)					
Color Stability	(See note #7)					

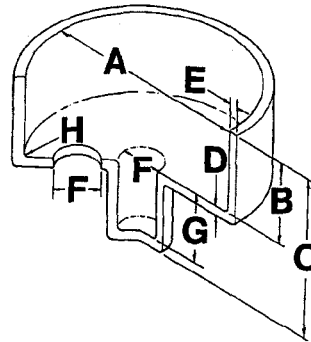

### REFERENCE NOTES

1. These tolerances do not include allowance for aging characteristics of material.
2. Tolerances are based on 0.125 inch wall section.
3. Parting line must be taken into consideration.
4. Part design should maintain a wall thickness as nearly constant as possible. Complete uniformity in this dimension is sometimes impossible to achieve. Walls of non-uniform thickness should be gradually blended from thick to thin.
5. Care must be taken that the ratio of the depth of a cored hole to its diameter does not reach a point that will result in excessive pin damage.
6. These values should be increased whenever compatible with desired design and good molding techniques.
7. Customer-Molder understanding is necessary prior to tooling.

# Standards & Practices of Plastics Molders

**Material**  
Melamine - Urea  
(MF-UF)

*Note:* The *Commercial* values shown below represent common production tolerances at the most economical level. The *Fine* values represent closer tolerances that can be held but at a greater cost. Any addition of fillers will compromise physical properties and alter dimensional stability. Please consult the manufacturer.

Drawing Code	Dimensions (mm)	Plus or Minus in Thousands of an Millimeter									
		50	100	150	200	250	300	350	400	450	500
A = Diameter (See note #1)  B = Depth (See note #3)  C = Height (See note #3)	0										
	25										
	50										
	75										
	100										
	125										
	150										
	150 to 300 for each additional 25 mm add (mm)	Comm. ±	Fine ±								
D = Bottom Wall	(See note #3)	0.130	0.075								
E = Side Wall	(See note #4)	0.105	0.050								
F = Hole Size Diameter (See note #1)	0.000 to 3.000	0.080	0.050								
	3.001 to 6.000	0.080	0.050								
	6.001 to 12.000	0.105	0.075								
	12.001 & over	0.130	0.100								
G = Hole Size Depth (See note #5)	0.000 to 6.000	0.080	0.050								
	6.001 to 12.000	0.100	0.050								
	12.001 to 25.000	0.130	0.050								
H = Corners, Ribs, Fillets	(See note #6)	0.765	0.380								
Flatness  (See note #4)	0.000 to 75.000	0.305	0.200								
	75.001 to 150.000	0.460	0.330								
Thread Size (Class)	Internal	1	2								
	External	1	2								
Concentricity	(See note #4) (F.I.M.)	0.180	0.125								
Draft Allowance Per Side	(See note #5)	1.0°	0.5°								
Surface Finish	(See note #7)										
Color Stability	(See note #7)										

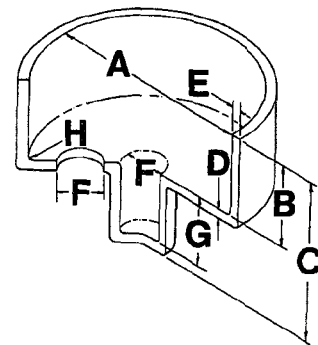

### REFERENCE NOTES

1. These tolerances do not include allowance for aging characteristics of material.
2. Tolerances are based on 3.175 mm wall section.
3. Parting line must be taken into consideration.
4. Part design should maintain a wall thickness as nearly constant as possible. Complete uniformity in this dimension is sometimes impossible to achieve. Walls of non-uniform thickness should be gradually blended from thick to thin.
5. Care must be taken that the ratio of the depth of a cored hole to its diameter does not reach a point that will result in excessive pin damage.
6. These values should be increased whenever compatible with desired design and good molding techniques.
7. Customer-Molder understanding is necessary prior to tooling.



# Standards & Practices of Plastics Molders

**Material**  
Melamine - Phenolic  
(MF-PF)

*Note:* The *Commercial* values shown below represent common production tolerances at the most economical level. The *Fine* values represent closer tolerances that can be held but at a greater cost. Any addition of fillers will compromise physical properties and alter dimensional stability. Please consult the manufacturer.

Drawing Code	Dimensions (Inches)	Plus or Minus in Thousands of an Inch				
		5	10	15	20	25
A = Diameter (See note #1)	0.000					
	0.500					
	1.000					
	2.000					
	3.000					
	4.000					
	5.000					
	6.000					
	6.000 to 12.000 for each additional inch add (inches)	Comm. ±	Fine ±			
		0.001	0.001			
D = Bottom Wall	(See note #3)	0.005	0.003			
E = Side Wall	(See note #4)	0.003	0.002			
F = Hole Size Diameter (See note #1)	0.000 to 0.125	0.002	0.001			
	0.126 to 0.250	0.002	0.001			
	0.251 to 0.500	0.003	0.002			
	0.501 & over	0.003	0.002			
G = Hole Size Depth (See note #5)	0.000 to 0.250	0.002	0.002			
	0.251 to 0.500	0.003	0.002			
	0.501 to 1.000	0.004	0.003			
H = Corners, Ribs, Fillets	(See note #6)	0.062	0.031			
Flatness (See note #8)	0.000 to 3.000					
	3.001 to 6.000					
Thread Size (Class)	Internal	1	2			
	External	1	2			
Concentricity	(See note #8) (F.I.M.)					
Draft Allowance Per Side		1.0°	0.5°			
Surface Finish	(See note #7)					
Color Stability	(See note #7)					

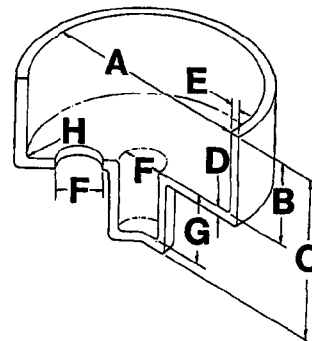

### REFERENCE NOTES

1. These tolerances do not include allowance for aging characteristics of material.
2. Tolerances are based on 0.125 inch wall section.
3. Parting line must be taken into consideration.
4. Part design should maintain a wall thickness as nearly constant as possible. Complete uniformity in this dimension is sometimes impossible to achieve. Walls of non-uniform thickness should be gradually blended from thick to thin.
5. Care must be taken that the ratio of the depth of a cored hole to its diameter does not reach a point that will result in excessive pin damage.
6. These values should be increased whenever compatible with desired design and good molding techniques.
7. Customer-Molder understanding is necessary prior to tooling.
8. These tolerances can vary greatly depending on method of molding and gate locations.

# Standards & Practices of Plastics Molders

**Material**  
Melamine - Phenolic  
(MF-PF)

*Note:* The *Commercial* values shown below represent common production tolerances at the most economical level. The *Fine* values represent closer tolerances that can be held but at a greater cost. Any addition of fillers will compromise physical properties and alter dimensional stability. Please consult the manufacturer.

Drawing Code	Dimensions (mm)	Plus or Minus in Thousands of an Millimeter									
		50	100	150	200	250	300	350	400	450	500
A = Diameter (See note #1)	0										
	25										
	50										
	75										
	100										
	125										
B = Depth (See note #3)	150										
	150 to 300 for each additional 25 mm add (mm)	Comm. ±	Fine ±								
D = Bottom Wall	(See note #3)	0.030	0.025								
E = Side Wall	(See note #4)	0.080	0.050								
F = Hole Size Diameter (See note #1)	0.000 to 3.000	0.055	0.025								
	3.001 to 6.000	0.055	0.025								
	6.001 to 12.000	0.080	0.050								
	12.001 & over	0.080	0.050								
G = Hole Size Depth (See note #5)	0.000 to 6.000	0.055	0.050								
	6.001 to 12.000	0.080	0.050								
	12.001 to 25.000	0.105	0.075								
H = Corners, Ribs, Fillets	(See note #6)	1.580	0.780								
Flatness (See note #8)	0.000 to 75.000										
	75.001 to 150.000										
Thread Size (Class)	Internal	1	2								
	External	1	2								
Concentricity	(See note #8 (F.I.M.))										
Draft Allowance Per Side		1.0°	0.5°								
Surface Finish	(See note #7)										
Color Stability	(See note #7)										

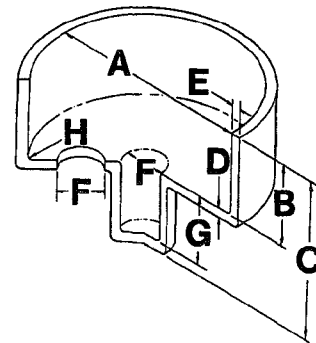

## REFERENCE NOTES

1. These tolerances do not include allowance for aging characteristics of material.
2. Tolerances are based on 3.175 mm wall section.
3. Parting line must be taken into consideration.
4. Part design should maintain a wall thickness as nearly constant as possible. Complete uniformity in this dimension is sometimes impossible to achieve. Walls of non-uniform thickness should be gradually blended from thick to thin.
5. Care must be taken that the ratio of the depth of a cored hole to its diameter does not reach a point that will result in excessive pin damage.
6. These values should be increased whenever compatible with desired design and good molding techniques.
7. Customer-Molder understanding is necessary prior to tooling.
8. These tolerances can vary greatly depending on method of molding and gate locations.

# Standards & Practices of Plastics Molders

**Material**  
Polyamide (Nylon)  
(PA)

*Note:* The *Commercial* values shown below represent common production tolerances at the most economical level. The *Fine* values represent closer tolerances that can be held but at a greater cost. Any addition of fillers will compromise physical properties and alter dimensional stability. Please consult the manufacturer.

Drawing Code	Dimensions (Inches)	Plus or Minus in Thousands of an Inch				
		5	10	15	20	25
A = Diameter (See note #1)  B = Depth (See note #3)  C = Height (See note #3)	0.000					
	0.500					
	1.000					
	2.000					
	3.000					
	4.000					
	5.000					
	6.000					
	6.000 to 12.000 for each additional inch add (inches)	Comm. ±	Fine ±			
D = Bottom Wall	(See note #3)	0.004	0.003			
E = Side Wall	(See note #4)	0.005	0.003			
F = Hole Size Diameter (See note #1)	0.000 to 0.125	0.002	0.001			
	0.126 to 0.250	0.003	0.002			
	0.251 to 0.500	0.003	0.002			
	0.501 & over	0.005	0.003			
G = Hole Size Depth (See note #5)	0.000 to 0.250	0.004	0.002			
	0.251 to 0.500	0.004	0.003			
	0.501 to 1.000	0.005	0.004			
H = Corners, Ribs, Fillets	(See note #6)	0.021	0.013			
Flatness (See note #4)	0.000 to 3.000	0.010	0.004			
	3.001 to 6.000	0.015	0.007			
Thread Size (Class)	Internal	1	2			
	External	1	2			
Concentricity	(See note #4) (F.I.M.)	0.005	0.003			
Draft Allowance Per Side		1.5°	0.5°			
Surface Finish	(See note #7)					
Color Stability	(See note #7)					

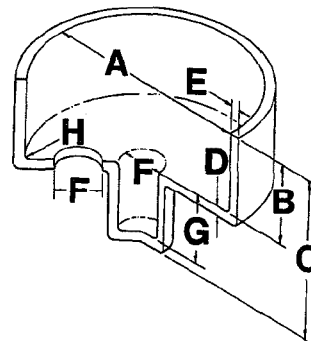

### REFERENCE NOTES

1. These tolerances do not include allowance for aging characteristics of material.
2. Tolerances are based on 0.125 inch wall section.
3. Parting line must be taken into consideration.
4. Part design should maintain a wall thickness as nearly constant as possible. Complete uniformity in this dimension is sometimes impossible to achieve. Walls of non-uniform thickness should be gradually blended from thick to thin.
5. Care must be taken that the ratio of the depth of a cored hole to its diameter does not reach a point that will result in excessive pin damage.
6. These values should be increased whenever compatible with desired design and good molding techniques.
7. Customer-Molder understanding is necessary prior to tooling.

# Standards & Practices of Plastics Molders

**Material**  
Polyamide (Nylon)  
(PA)

*Note:* The *Commercial* values shown below represent common production tolerances at the most economical level. The *Fine* values represent closer tolerances that can be held but at a greater cost. Any addition of fillers will compromise physical properties and alter dimensional stability. Please consult the manufacturer.

Drawing Code	Dimensions (mm)	Plus or Minus in Thousands of an Millimeter									
		50	100	150	200	250	300	350	400	450	500
A = Diameter (See note #1)  B = Depth (See note #3)  C = Height (See note #3)	0										
	25										
	50										
	75										
	100										
	125										
	150										
	150 to 300 for each additional 25 mm add (mm)	Comm. ±	Fine ±								
D = Bottom Wall	(See note #3)	0.105	0.075								
E = Side Wall	(See note #4)	0.130	0.075								
F = Hole Size Diameter (See note #1)	0.000 to 3.000	0.055	0.025								
	3.001 to 6.000	0.080	0.050								
	6.001 to 12.000	0.080	0.050								
	12.001 & over	0.130	0.075								
G = Hole Size Depth (See note #5)	0.000 to 6.000	0.105	0.050								
	6.001 to 12.000	0.105	0.075								
	12.001 to 25.000	0.130	0.100								
H = Corners, Ribs, Fillets	(See note #6)	0.535	0.330								
Flatness (See note #4)	0.000 to 75.000	0.255	0.100								
	75.001 to 150.000	0.385	0.175								
Thread Size (Class)	Internal	1	2								
	External	1	2								
Concentricity	(See note #4) (F.I.M.)	0.130	0.075								
Draft Allowance Per Side	(See note #5)	1.5°	0.5°								
Surface Finish	(See note #7)										
Color Stability	(See note #7)										

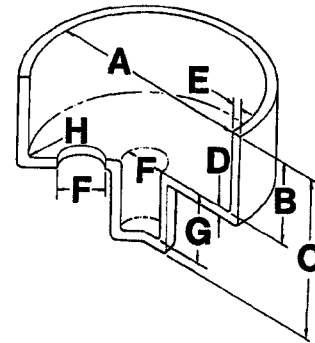

## REFERENCE NOTES

1. These tolerances do not include allowance for aging characteristics of material.
2. Tolerances are based on 3.175 mm wall section.
3. Parting line must be taken into consideration.
4. Part design should maintain a wall thickness as nearly constant as possible. Complete uniformity in this dimension is sometimes impossible to achieve. Walls of non-uniform thickness should be gradually blended from thick to thin.
5. Care must be taken that the ratio of the depth of a cored hole to its diameter does not reach a point that will result in excessive pin damage.
6. These values should be increased whenever compatible with desired design and good molding techniques.
7. Customer-Molder understanding is necessary prior to tooling.

# Standards & Practices of Plastics Molders

**Material**  
Polycarbonate  
(PC)

*Note:* The *Commercial* values shown below represent common production tolerances at the most economical level. The *Fine* values represent closer tolerances that can be held but at a greater cost. Any addition of fillers will compromise physical properties and alter dimensional stability. Please consult the manufacturer.

Drawing Code	Dimensions (Inches)	Plus or Minus in Thousands of an Inch (See note #1)				
		5	10	15	20	25
A = Diameter (See note #1)	0.000					
	0.500					
	1.000					
	2.000					
	3.000					
	4.000					
B = Depth (See note #2)	5.000					
	6.000					
C = Height (See note #2)	6.000 to 12.000 for each additional inch add (inches)	Comm. ±	Fine ±			
		0.002	0.002			
D = Bottom Wall	(See note #3)	0.004	0.002			
E = Side Wall	(See note #6)	0.005	0.003			
F = Hole Size Diameter (See note #1)	0.000 to 0.125	0.002	0.001			
	0.126 to 0.250	0.002	0.002			
	0.251 to 0.500	0.003	0.002			
	0.501 & over	0.003	0.002			
G = Hole Size Depth (See note #5)	0.000 to 0.250	0.002	0.002			
	0.251 to 0.500	0.003	0.002			
	0.501 to 1.000	0.004	0.003			
H = Corners, Ribs, Fillets	(See note #6)	0.020	0.015			
Flatness (See note #4)	0.000 to 3.000	0.005	0.003			
	3.001 to 6.000	0.007	0.004			
Thread Size (Class)	Internal	1B	2B			
	External	1A	2A			
Concentricity	(See note #4) (F.I.M.)	0.005	0.003			
Draft Allowance Per Side	(See note #7)	1.5°	0.5°			
Surface Finish	(See note #8)					
Color Stability	(See note #8)					

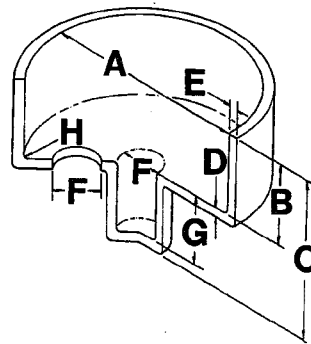

### REFERENCE NOTES

1. These tolerances do not include allowance for aging characteristics of material
2. Tolerances do not apply to screw threads, gear teeth or match fits.
3. Parting line must be taken into consideration.
4. Part design should maintain a wall thickness as nearly constant as possible. Complete uniformity in this dimension is sometimes impossible to achieve. Walls of non-uniform thickness should be gradually blended from thick to thin.
5. Care must be taken that the ratio of the depth of a cored hole to its diameter does not reach a point that will result in excessive pin damage.
6. This dimension is a function of mold design and construction.
7. These values should be considered minimum.
8. Customer-Molder understanding is necessary prior to tooling.

# Standards & Practices of Plastics Molders

**Material**  
Polycarbonate  
(PC)

*Note:* The *Commercial* values shown below represent common production tolerances at the most economical level. The *Fine* values represent closer tolerances that can be held but at a greater cost. Any addition of fillers will compromise physical properties and alter dimensional stability. Please consult the manufacturer.

Drawing Code	Dimensions (mm)	Plus or Minus in Thousands of an Millimeter (See note #1)									
		50	100	150	200	250	300	350	400	450	500
A = Diameter (See note #1)	0										
	25										
	50										
	75										
	100										
	125										
B = Depth (See note #2)	150										
	150 to 300 for each additional 25 mm add (mm)	Comm. ±	Fine ±								
D = Bottom Wall	(See note #3)	0.055	0.050								
E = Side Wall	(See note #6)	0.105	0.050								
F = Hole Size Diameter (See note #1)	0.000 to 3.000	0.055	0.025								
	3.001 to 6.000	0.055	0.050								
	6.001 to 12.000	0.080	0.050								
	12.001 & over	0.080	0.050								
G = Hole Size Depth (See note #5)	0.000 to 6.000	0.055	0.050								
	6.001 to 12.000	0.080	0.050								
	12.001 to 25.000	0.105	0.075								
H = Corners, Ribs, Fillets	(See note #6)	0.510	0.380								
Flatness (See note #4)	0.000 to 75.000	0.130	0.075								
	75.001 to 150.000	0.180	0.100								
Thread Size (Class)	Internal	1B	2B								
	External	1A	2A								
Concentricity	(See note #4) (F.I.M.)	0.130	0.075								
Draft Allowance Per Side	(See note #7)	1.5°	0.5°								
Surface Finish	(See note #8)										
Color Stability	(See note #8)										

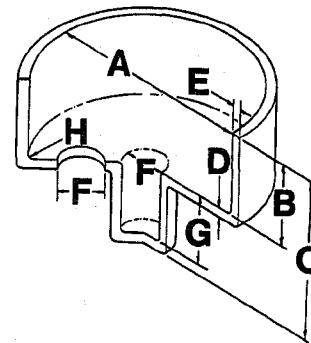

## REFERENCE NOTES

1. These tolerances do not include allowance for aging characteristics of material.
2. Tolerances do not apply to screw threads, gear teeth or match fits.
3. Parting line must be taken into consideration.
4. Part design should maintain a wall thickness as nearly constant as possible. Complete uniformity in this dimension is sometimes impossible to achieve. Walls of non-uniform thickness should be gradually blended from thick to thin.
5. Care must be taken that the ratio of the depth of a cored hole to its diameter does not reach a point that will result in excessive pin damage.
6. This dimension is a function of mold design and construction.
7. These values should be considered minimum.
8. Customer-Molder understanding is necessary prior to tooling.

# Standards & Practices of Plastics Molders

**Material**  
Polyetherimide  
(PEI)

*Note:* The *Commercial* values shown below represent common production tolerances at the most economical level. The *Fine* values represent closer tolerances that can be held but at a greater cost. Any addition of fillers will compromise physical properties and alter dimensional stability. Please consult the manufacturer.

Drawing Code	Dimensions (Inches)	Plus or Minus in Thousands of an Inch (See note #1)				
		5	10	15	20	25
A = Diameter (See note #1)	0.000					
	0.500					
	1.000					
	2.000					
	3.000					
	4.000					
B = Depth (See note #2)	5.000					
	6.000					
C = Height (See note #2)	6.000 to 12.000 for each additional inch add (inches)	Comm. ±	Fine ±			
		0.001	0.0005			
D = Bottom Wall	(See note #2)	0.001	0.0005			
E = Side Wall	(See note #2)	0.001	0.0005			
F = Hole Size Diameter	0.000 to 0.125	0.001	0.0005			
	0.126 to 0.250	0.001	0.0005			
	0.251 to 0.500	0.0015	0.001			
	0.501 & over	0.002	0.0015			
G = Hole Size Depth	0.000 to 0.250	0.001	0.0005			
	0.251 to 0.500	0.001	0.0005			
	0.501 to 1.000	0.015	0.001			
H = Corners, Ribs, Fillets	0.025 to 0.062	0.005	0.005			
Flatness (See note #3)	0.000 to 3.000	0.007	0.003			
	3.001 to 6.000	0.010	0.007			
Thread Size (Class)	Internal					
	External					
Concentricity	(See note #5) (F.I.M.)					
Draft Allowance Per Side	(See note #4)	1.5°	0.25°			
Surface Finish	(See note #6)					
Color Stability	(See note #6)					

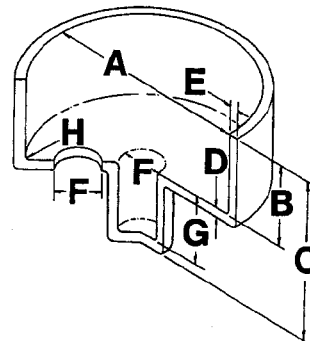

### REFERENCE NOTES

1. Tolerances do not apply to screw threads, gear teeth or match fits. Provisions can usually be made to hold this type of dimension to close limits.
2. Parting line must be taken into consideration.
3. Part design should maintain a wall thickness as nearly constant as possible. Complete uniformity in this dimension is sometimes impossible to achieve. Walls of non-uniform thickness should be gradually blended from thick to thin.
4. These values should be considered minimum. The designer should allow as much draft as is compatible with his design. Liberal use of draft will minimize ejection problems, and reduce distortion due to ejection.
5. This dimension is a function of mold design and construction.
6. Customer-Molder understanding is necessary prior to tooling.

# Standards & Practices of Plastics Molders

**Material**  
Polyetherimide  
(PEI)

*Note:* The *Commercial* values shown below represent common production tolerances at the most economical level. The *Fine* values represent closer tolerances that can be held but at a greater cost. Any addition of fillers will compromise physical properties and alter dimensional stability. Please consult the manufacturer.

Drawing Code	Dimensions (mm)	Plus or Minus in Thousands of an Millimeter (See note #1)									
		50	100	150	200	250	300	350	400	450	500
A = Diameter (See note #1)	0										
	25										
	50										
	75										
	100										
	125										
B = Depth (See note #2)	150										
	150 to 300 for each additional 25 mm add (mm)										
C = Height (See note #2)											
D = Bottom Wall	(See note #2)										
E = Side Wall	(See note #2)										
F = Hole Size Diameter (See note #1)	0.000 to 3.000										
	3.001 to 6.000										
	6.001 to 12.000										
	12.001 & over										
G = Hole Size Depth	0.000 to 6.000										
	6.001 to 12.000										
	12.001 to 25.000										
H = Corners, Ribs, Fillets	(See note #6)										
Flatness (See note #3)	0.000 to 75.000										
	75.001 to 150.000										
Thread Size (Class)	Internal										
	External										
Concentricity	(See note #5) (F.I.M.)										
Draft Allowance Per Side	(See note #4)										
Surface Finish	(See note #6)										
Color Stability	(See note #6)										

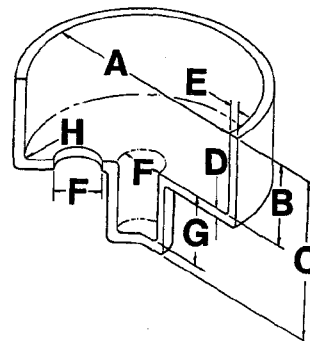

## REFERENCE NOTES

1. Tolerances do not apply to screw threads, gear teeth or match fits. Provisions can usually be made to hold this type of dimension to close limits.
2. Parting line must be taken into consideration.
3. Part design should maintain a wall thickness as nearly constant as possible. Complete uniformity in this dimension is sometimes impossible to achieve. Walls of non-uniform thickness should be gradually blended from thick to thin.
4. These values should be considered minimum. The designer should allow as much draft as is compatible with his design. Liberal use of draft will minimize ejection problems, and reduce distortion due to ejection.
5. This dimension is a function of mold design and construction.
6. Customer-Molder understanding is necessary prior to tooling.



# Standards & Practices of Plastics Molders

**Material**  
Polyethylene-Terephthalate  
(PETE)

*Note:* The *Commercial* values shown below represent common production tolerances at the most economical level. The *Fine* values represent closer tolerances that can be held but at a greater cost. Any addition of fillers will compromise physical properties and alter dimensional stability. Please consult the manufacturer.

Drawing Code	Dimensions (Inches)	Plus or Minus in Thousands of an Inch				
		5	10	15	20	25
A = Diameter (See note #1)	0.000					
	0.500					
	1.000					
	2.000					
	3.000					
	4.000					
	5.000					
B = Depth (See note #3)	6.000					
	6.000 to 12.000 for each additional inch add (inches)	Comm. ±	Fine ±			
C = Height (See note #3)		0.003	0.002			
	D = Bottom Wall	(See note #3)	0.004	0.002		
E = Side Wall	(See note #4)	0.004	0.002			
F = Hole Size Diameter (See note #1)	0.000 to 0.125	0.002	0.001			
	0.126 to 0.250	0.003	0.001			
	0.251 to 0.500	0.003	0.002			
	0.501 & over	0.004	0.002			
G = Hole Size Depth (See note #5)	0.000 to 0.250	0.003	0.002			
	0.251 to 0.500	0.004	0.002			
	0.501 to 1.000	0.005	0.003			
H = Corners, Ribs, Fillets	(See note #6)	0.030	0.016			
Flatness	0.000 to 3.000	0.013	0.008			
(See note #4)	3.001 to 6.000	0.023	0.013			
Thread Size (Class)	Internal	1	2			
	External	1	2			
Concentricity	(See note #4) (F.I.M.)					
Draft Allowance Per Side	(See note #5)	1.75°	0.75°			
Surface Finish	(See note #7)	#2	#1			
Color Stability	(See note #7)					

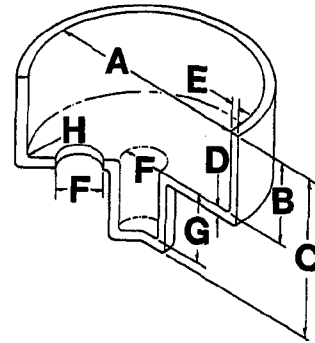

## REFERENCE NOTES

1. These tolerances do not include allowance for aging characteristics of material.
2. Tolerances are based on 0.125 inch wall section.
3. Parting line must be taken into consideration.
4. Part design should maintain a wall thickness as nearly constant as possible. Complete uniformity in this dimension is sometimes impossible to achieve. Walls of non-uniform thickness should be gradually blended from thick to thin.
5. Care must be taken that the ratio of the depth of a cored hole to its diameter does not reach a point that will result in excessive pin damage.
6. These values should be increased whenever compatible with desired design and good molding techniques.
7. Customer-Molder understanding is necessary prior to tooling.

# Standards & Practices of Plastics Molders

**Material**  
Polyethylene-Terephthalate  
(PETE)

*Note:* The *Commercial* values shown below represent common production tolerances at the most economical level. The *Fine* values represent closer tolerances that can be held but at a greater cost. Any addition of fillers will compromise physical properties and alter dimensional stability. Please consult the manufacturer.

Drawing Code	Dimensions (mm)	Plus or Minus in Thousands of an Millimeter									
		50	100	150	200	250	300	350	400	450	500
A = Diameter (See note #1)	0										
	25										
	50										
	75										
	100										
	125										
B = Depth (See note #3)	150										
	150 to 300 for each additional 25 mm add (mm)										
C = Height (See note #3)											
D = Bottom Wall	(See note #3)										
E = Side Wall	(See note #4)										
F = Hole Size Diameter (See note #1)	0.000 to 3.000										
	3.001 to 6.000										
	6.001 to 12.000										
	12.001 & over										
G = Hole Size Depth (See note #5)	0.000 to 6.000										
	6.001 to 12.000										
	12.001 to 25.000										
H = Corners, Ribs, Fillets	(See note #6)										
Flatness (See note #4)	0.000 to 75.000										
	75.001 to 150.000										
Thread Size (Class)	Internal										
	External										
Concentricity	(See note #4) (F.I.M.)										
Draft Allowance Per Side	(See note #5)										
Surface Finish	(See note #7)										
Color Stability	(See note #7)										

Comm. ±	Fine ±
0.080	0.050

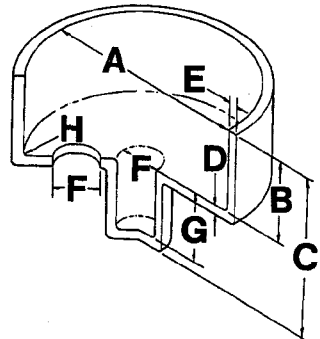

### REFERENCE NOTES

1. These tolerances do not include allowance for aging characteristics of material.
2. Tolerances are based on 3.175 mm wall section.
3. Parting line must be taken into consideration.
4. Part design should maintain a wall thickness as nearly constant as possible. Complete uniformity in this dimension is sometimes impossible to achieve. Walls of non-uniform thickness should be gradually blended from thick to thin.
5. Care must be taken that the ratio of the depth of a cored hole to its diameter does not reach a point that will result in excessive pin damage.
6. These values should be increased whenever compatible with desired design and good molding techniques.
7. Customer-Molder understanding is necessary prior to tooling.

# Standards & Practices of Plastics Molders

**Material**  
Phenol-Formaldehyde (PF)  
(Phenolic) (Fibre-filled)

*Note:* The *Commercial* values shown below represent common production tolerances at the most economical level. The *Fine* values represent closer tolerances that can be held but at a greater cost. Any addition of fillers will compromise physical properties and alter dimensional stability. Please consult the manufacturer.

Drawing Code	Dimensions (Inches)	Plus or Minus in Thousands of an Inch				
		5	10	15	20	25
A = Diameter (See note #1)	0.000					
	0.500					
	1.000					
	2.000					
	3.000					
	4.000					
	5.000					
B = Depth (See note #3)	6.000					
	6.000 to 12.000 for each additional inch add (inches)	Comm. ±	Fine ±			
D = Bottom Wall	(See note #3)	0.006	0.004			
E = Side Wall	(See note #4)	0.004	0.003			
F = Hole Size Diameter (See note #1)	0.000 to 0.125	0.002	0.001			
	0.126 to 0.250	0.003	0.002			
	0.251 to 0.500	0.004	0.003			
	0.501 & over	0.005	0.003			
G = Hole Size Depth (See note #5)	0.000 to 0.250	0.004	0.002			
	0.251 to 0.500	0.005	0.003			
	0.501 to 1.000	0.007	0.004			
H = Corners, Ribs, Fillets	(See note #6)	0.030	0.015			
Flatness (See note #4)	0.000 to 3.000	0.014	0.008			
	3.001 to 6.000	0.021	0.014			
Thread Size (Class)	Internal	1	2			
	External	1	2			
Concentricity	(See note #4) (F.I.M.)	0.007	0.004			
Draft Allowance Per Side	(See note #5)	1.0°	0.5°			
Surface Finish	(See note #7)					
Color Stability	(See note #7)					

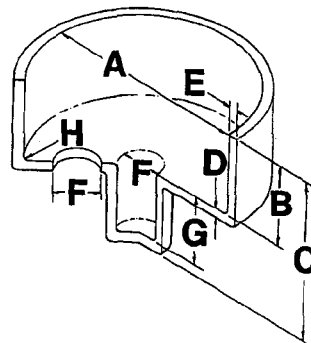

### REFERENCE NOTES

1. These tolerances do not include allowance for aging characteristics of material.
2. Tolerances are based on 0.125 inch wall section.
3. Parting line must be taken into consideration.
4. Part design should maintain a wall thickness as nearly constant as possible. Complete uniformity in this dimension is sometimes impossible to achieve. Walls of non-uniform thickness should be gradually blended from thick to thin.
5. Care must be taken that the ratio of the depth of a cored hole to its diameter does not reach a point that will result in excessive pin damage.
6. These values should be increased whenever compatible with desired design and good molding techniques.
7. Customer-Molder understanding is necessary prior to tooling.

# Standards & Practices of Plastics Molders

**Material**  
Phenol-Formaldehyde (PF)  
(Phenolic) (Fibre-filled)

*Note:* The *Commercial* values shown below represent common production tolerances at the most economical level. The *Fine* values represent closer tolerances that can be held but at a greater cost. Any addition of fillers will compromise physical properties and alter dimensional stability. Please consult the manufacturer.

Drawing Code	Dimensions (mm)	Plus or Minus in Thousands of an Millimeter									
		50	100	150	200	250	300	350	400	450	500
A = Diameter (See note #1)	0										
	25										
	50										
	75										
	100										
	125										
B = Depth (See note #3)	150										
	150 to 300 for each additional 25 mm add (mm)	Comm. ±	Fine ±								
D = Bottom Wall	(See note #3)	0.080	0.050								
E = Side Wall	(See note #4)	0.155	0.100								
F = Hole Size Diameter (See note #1)	0.000 to 3.000	0.055	0.025								
	3.001 to 6.000	0.080	0.050								
	6.001 to 12.000	0.105	0.075								
	12.001 & over	0.130	0.075								
G = Hole Size Depth (See note #5)	0.000 to 6.000	0.105	0.050								
	6.001 to 12.000	0.130	0.075								
	12.001 to 25.000	0.180	0.100								
H = Corners, Ribs, Fillets	(See note #6)	0.765	0.380								
Flatness (See note #4)	0.000 to 75.000	0.360	0.200								
	75.001 to 150.000	0.535	0.355								
Thread Size (Class)	Internal	1	2								
	External	1	2								
Concentricity	(See note #4) (F.I.M.)	0.180	0.100								
Draft Allowance Per Side	(See note #5)	1.0°	0.5°								
Surface Finish	(See note #7)										
Color Stability	(See note #7)										

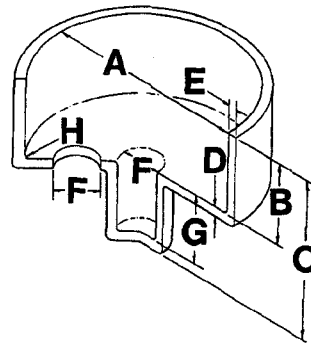

### REFERENCE NOTES

1. These tolerances do not include allowance for aging characteristics of material.
2. Tolerances are based on 3.175 mm wall section.
3. Parting line must be taken into consideration.
4. Part design should maintain a wall thickness as nearly constant as possible. Complete uniformity in this dimension is sometimes impossible to achieve. Walls of non-uniform thickness should be gradually blended from thick to thin.
5. Care must be taken that the ratio of the depth of a cored hole to its diameter does not reach a point that will result in excessive pin damage.
6. These values should be increased whenever compatible with desired design and good molding techniques.
7. Customer-Molder understanding is necessary prior to tooling.

# Standards & Practices of Plastics Molders

**Material**  
Phenol-Formaldehyde (PF)  
(Phenolic) General Purpose

*Note:* The *Commercial* values shown below represent common production tolerances at the most economical level. The *Fine* values represent closer tolerances that can be held but at a greater cost. Any addition of fillers will compromise physical properties and alter dimensional stability. Please consult the manufacturer.

Drawing Code	Dimensions (Inches)	Plus or Minus in Thousands of an Inch				
		5	10	15	20	25
A = Diameter (See note #1)	0.000					
	0.500					
	1.000					
	2.000					
	3.000					
	4.000					
	5.000					
B = Depth (See note #3)	6.000					
	6.000 to 12.000 for each additional inch add (inches)	Comm. ± 0.002	Fine ± 0.001			
D = Bottom Wall	(See note #3)	0.007	0.004			
E = Side Wall	(See note #4)	0.004	0.002			
F = Hole Size Diameter (See note #1)	0.000 to 0.125	0.002	0.001			
	0.126 to 0.250	0.002	0.001			
	0.251 to 0.500	0.003	0.002			
	0.501 & over	0.003	0.002			
G = Hole Size Depth (See note #5)	0.000 to 0.250	0.003	0.002			
	0.251 to 0.500	0.004	0.002			
	0.501 to 1.000	0.005	0.003			
H = Corners, Ribs, Fillets	(See note #6)	0.062	0.031			
Flatness (See note #8)	0.000 to 3.000	0.010	0.005			
	3.001 to 6.000	0.012	0.010			
Thread Size (Class)	Internal	1	2			
	External	1	2			
Concentricity	(See note #8) (F.I.M.)	0.005	0.003			
Draft Allowance Per Side		1.0°	0.5°			
Surface Finish	(See note #7)					
Color Stability	(See note #7)					

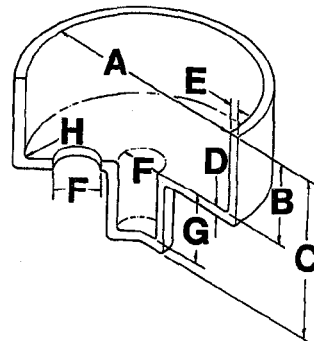

### REFERENCE NOTES

1. These tolerances do not include allowance for aging characteristics of material.
2. Tolerances are based on 0.125 inch wall section.
3. Parting line must be taken into consideration.
4. Part design should maintain a wall thickness as nearly constant as possible. Complete uniformity in this dimension is sometimes impossible to achieve. Walls of non-uniform thickness should be gradually blended from thick to thin.
5. Care must be taken that the ratio of the depth of a cored hole to its diameter does not reach a point that will result in excessive pin damage.
6. These values should be increased whenever compatible with desired design and good molding techniques.
7. Customer-Molder understanding is necessary prior to tooling.
8. These tolerances can vary greatly depending on method of molding and gate location.

# Standards & Practices of Plastics Molders

**Material**  
Phenol-Formaldehyde (PF)  
(Phenolic) General Purpose

*Note:* The *Commercial* values shown below represent common production tolerances at the most economical level. The *Fine* values represent closer tolerances that can be held but at a greater cost. Any addition of fillers will compromise physical properties and alter dimensional stability. Please consult the manufacturer.

Drawing Code	Dimensions (mm)	Plus or Minus in Thousands of an Millimeter																			
		50	100	150	200	250	300	350	400	450	500										
	0																				
A = Diameter (See note #1)	25																				
B = Depth (See note #3)	50																				
	75																				
C = Height (See note #3)	100																				
	125																				
	150																				
	150 to 300 for each additional 25 mm add (mm)																				
		Comm. ±	Fine ±																		
D = Bottom Wall	(See note #3)	0.050	0.025																		
E = Side Wall	(See note #4)	0.105	0.050																		
F = Hole Size Diameter (See note #1)	0.000 to 3.000	0.055	0.025																		
	3.001 to 6.000	0.055	0.025																		
	6.001 to 12.000	0.080	0.050																		
	12.001 & over	0.080	0.050																		
G = Hole Size Depth (See note #5)	0.000 to 6.000	0.080	0.050																		
	6.001 to 12.000	0.105	0.050																		
	12.001 to 25.000	0.130	0.075																		
H = Corners, Ribs, Fillets	(See note #6)	1.580	0.780																		
Flatness (See note #8)	0.000 to 75.000	0.305	0.125																		
	75.001 to 150.000	0.305	0.250																		
Thread Size (Class)	Internal	1	2																		
	External	1	2																		
Concentricity	(See note #8) (F.I.M.)	0.130	0.075																		
Draft Allowance Per Side		1.0°	0.5°																		
Surface Finish	(See note #7)																				
Color Stability	(See note #7)																				

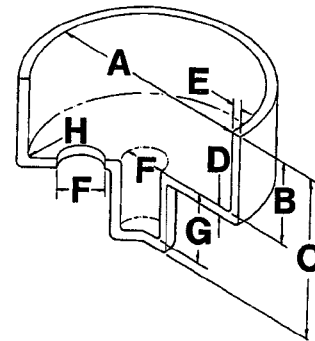

### REFERENCE NOTES

1. These tolerances do not include allowance for aging characteristics of material.
2. Tolerances are based on 3.175 mm wall section.
3. Parting line must be taken into consideration.
4. Part design should maintain a wall thickness as nearly constant as possible. Complete uniformity in this dimension is sometimes impossible to achieve. Walls of non-uniform thickness should be gradually blended from thick to thin.
5. Care must be taken that the ratio of the depth of a cored hole to its diameter does not reach a point that will result in excessive pin damage.
6. These values should be increased whenever compatible with desired design and good molding techniques.
7. Customer-Molder understanding is necessary prior to tooling.
8. These tolerances can vary greatly depending on method of molding and gate location.

# Standards & Practices of Plastics Molders

**Material**  
Phenol-Formaldehyde (PF)  
(Phenolic) Glass Filled

*Note:* The *Commercial* values shown below represent common production tolerances at the most economical level. The *Fine* values represent closer tolerances that can be held but at a greater cost. Any addition of fillers will compromise physical properties and alter dimensional stability. Please consult the manufacturer.

Drawing Code	Dimensions (Inches)	Plus or Minus in Thousands of an Inch					
		5	10	15	20	25	
A = Diameter (See note #1)	0.000	Fine Commercial					
	0.500						
	1.000						
	2.000						
	3.000						
	4.000						
B = Depth (See note #3)	5.000						
	6.000						
C = Height (See note #3)	6.000 to 12.000 for each additional inch add (inches)	Comm. ±	Fine ±				
		0.001	0.001				
D = Bottom Wall	(See note #3)	0.005	0.003				
E = Side Wall	(See note #4)	0.001	0.001				
F = Hole Size Diameter (See note #1)	0.000 to 0.125	0.001	0.001				
	0.126 to 0.250	0.001	0.001				
	0.251 to 0.500	0.001	0.001				
	0.501 & over	0.002	0.001				
G = Hole Size Depth (See note #5)	0.000 to 0.250	0.001	0.001				
	0.251 to 0.500	0.001	0.001				
	0.501 to 1.000	0.002	0.001				
H = Corners, Ribs, Fillets	(See note #6)	0.062	0.031				
Flatness (See note #8)	0.000 to 3.000						
	3.001 to 6.000						
Thread Size (Class)	Internal	1	2				
	External	1	2				
Concentricity	(See note #8) (F.I.M.)	0.005	0.003				
Draft Allowance Per Side		1.0°	0.5°				
Surface Finish	(See note #7)						
Color Stability	(See note #7)						

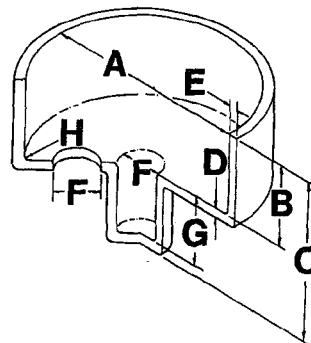

## REFERENCE NOTES

1. These tolerances do not include allowance for aging characteristics of material.
2. Tolerances are based on 0.125 inch wall section.
3. Parting line must be taken into consideration.
4. Part design should maintain a wall thickness as nearly constant as possible. Complete uniformity in this dimension is sometimes impossible to achieve. Walls of non-uniform thickness should be gradually blended from thick to thin.
5. Care must be taken that the ratio of the depth of a cored hole to its diameter does not reach a point that will result in excessive pin damage.
6. These values should be increased whenever compatible with desired design and good molding techniques.
7. Customer-Molder understanding is necessary prior to tooling.
8. These tolerances can vary greatly depending on method of molding and gate location.

# Standards & Practices of Plastics Molders

**Material**  
Phenol-Formaldehyde (PF)  
(Phenolic) Glass Filled

*Note:* The *Commercial* values shown below represent common production tolerances at the most economical level. The *Fine* values represent closer tolerances that can be held but at a greater cost. Any addition of fillers will compromise physical properties and alter dimensional stability. Please consult the manufacturer.

Drawing Code	Dimensions (mm)	Plus or Minus in Thousands of an Millimeter										
		50	100	150	200	250	300	350	400	450	500	
A = Diameter (See note #1)	0											
	25											
	50											
	75											
	100											
	125											
	150											
	150 to 300 for each additional 25 mm add (mm)	Comm. ±	Fine ±									
D = Bottom Wall	(See note #3)	0.030	0.025									
E = Side Wall	(See note #4)	0.030	0.025									
F = Hole Size Diameter (See note #1)	0.000 to 3.000	0.030	0.025									
	3.001 to 6.000	0.030	0.025									
	6.001 to 12.000	0.030	0.025									
	12.001 & over	0.055	0.025									
G = Hole Size Depth (See note #5)	0.000 to 6.000	0.030	0.025									
	6.001 to 12.000	0.030	0.025									
	12.001 to 25.000	0.055	0.025									
H = Corners, Ribs, Fillets	(See note #6)	1.580	0.780									
Flatness (See note #8)	0.000 to 75.000											
	75.001 to 150.000											
Thread Size (Class)	Internal	1	2									
	External	1	2									
Concentricity	(See note #8) (F.I.M.)	0.130	0.075									
Draft Allowance Per Side		1.0°	0.5°									
Surface Finish	(See note #7)											
Color Stability	(See note #7)											

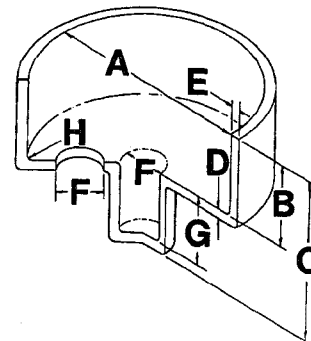

### REFERENCE NOTES

1. These tolerances do not include allowance for aging characteristics of material.
2. Tolerances are based on 3.175 mm wall section.
3. Parting line must be taken into consideration.
4. Part design should maintain a wall thickness as nearly constant as possible. Complete uniformity in this dimension is sometimes impossible to achieve. Walls of non-uniform thickness should be gradually blended from thick to thin.
5. Care must be taken that the ratio of the depth of a cored hole to its diameter does not reach a point that will result in excessive pin damage.
6. These values should be increased whenever compatible with desired design and good molding techniques.
7. Customer-Molder understanding is necessary prior to tooling.
8. These tolerances can vary greatly depending on method of molding and gate location.



# Standards & Practices of Plastics Molders

**Material**  
Polyoxymethylene  
(Acetal) (POM)

*Note:* The *Commercial* values shown below represent common production tolerances at the most economical level. The *Fine* values represent closer tolerances that can be held but at a greater cost. Any addition of fillers will compromise physical properties and alter dimensional stability. Please consult the manufacturer.

Drawing Code	Dimensions (Inches)	Plus or Minus in Thousands of an Inch				
		5	10	15	20	25
A = Diameter (See note #1)	0.000					
	0.500					
	1.000					
	2.000					
	3.000					
	4.000					
B = Depth (See note #3)	5.000					
	6.000					
C = Height (See note #3)	6.000 to 12.000 for each additional inch add (inches)	Comm. ±	Fine ±			
		0.004	0.002			
D = Bottom Wall	(See note #3)	0.004	0.002			
E = Side Wall	(See note #4)	0.004	0.002			
F = Hole Size Diameter (See note #1)	0.000 to 0.125	0.002	0.001			
	0.126 to 0.250	0.003	0.002			
	0.251 to 0.500	0.004	0.002			
	0.501 & over	0.005	0.003			
G = Hole Size Depth (See note #5)	0.000 to 0.250	0.004	0.002			
	0.251 to 0.500	0.005	0.003			
	0.501 to 1.000	0.006	0.004			
H = Corners, Ribs, Fillets	(See note #6)	0.025	0.013			
Flatness (See note #4)	0.000 to 3.000	0.011	0.005			
	3.001 to 6.000	0.018	0.008			
Thread Size (Class)	Internal	1	2			
	External	1	2			
Concentricity	(See note #4) (F.I.M.)	0.010	0.006			
Draft Allowance Per Side	(See note #5)	1.25°	0.5°			
Surface Finish	(See note #7)					
Color Stability	(See note #7)					

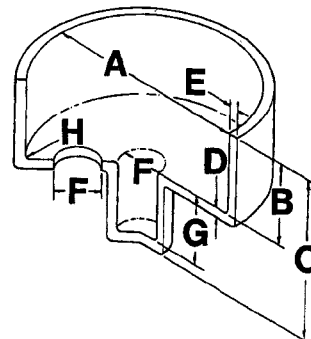

### REFERENCE NOTES

1. These tolerances do not include allowance for aging characteristics of material.
2. Tolerances are based on 0.125 inch wall section.
3. Parting line must be taken into consideration.
4. Part design should maintain a wall thickness as nearly constant as possible. Complete uniformity in this dimension is sometimes impossible to achieve. Walls of non-uniform thickness should be gradually blended from thick to thin.
5. Care must be taken that the ratio of the depth of a cored hole to its diameter does not reach a point that will result in excessive pin damage.
6. These values should be increased whenever compatible with desired design and good molding techniques.
7. Customer-Molder understanding is necessary prior to tooling.

# Standards & Practices of Plastics Molders

**Material**  
Polyoxymethylene  
(Acetal) (POM)

*Note:* The *Commercial* values shown below represent common production tolerances at the most economical level. The *Fine* values represent closer tolerances that can be held but at a greater cost. Any addition of fillers will compromise physical properties and alter dimensional stability. Please consult the manufacturer.

Drawing Code	Dimensions (mm)	Plus or Minus in Thousands of an Millimeter									
		50	100	150	200	250	300	350	400	450	500
A = Diameter (See note #1)  B = Depth (See note #3)  C = Height (See note #3)	0										
	25										
	50										
	75										
	100										
	125										
	150										
	150 to 300 for each additional 25 mm add (mm)	Comm. ±	Fine ±								
D = Bottom Wall	(See note #3)	0.105	0.050								
E = Side Wall	(See note #4)	0.105	0.050								
F = Hole Size Diameter (See note #1)	0.000 to 3.000	0.055	0.025								
	3.001 to 6.000	0.080	0.050								
	6.001 to 12.000	0.105	0.050								
	12.001 & over	0.130	0.075								
G = Hole Size Depth (See note #5)	0.000 to 6.000	0.105	0.050								
	6.001 to 12.000	0.130	0.075								
	12.001 to 25.000	0.155	0.100								
H = Corners, Ribs, Fillets	(See note #6)	0.635	0.305								
Flatness (See note #4)	0.000 to 75.000	0.280	0.125								
	75.001 to 150.000	0.460	0.200								
Thread Size (Class)	Internal	1	2								
	External	1	2								
Concentricity	(See note #4) (F.I.M.)	0.255	0.150								
Draft Allowance Per Side	(See note #5)	1.25°	0.5°								
Surface Finish	(See note #7)										
Color Stability	(See note #7)										

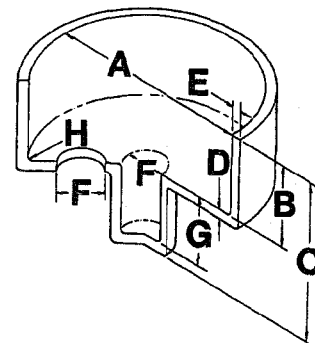

### REFERENCE NOTES

1. These tolerances do not include allowance for aging characteristics of material.
2. Tolerances are based on 3.175 mm wall section.
3. Parting line must be taken into consideration.
4. Part design should maintain a wall thickness as nearly constant as possible. Complete uniformity in this dimension is sometimes impossible to achieve. Walls of non-uniform thickness should be gradually blended from thick to thin.
5. Care must be taken that the ratio of the depth of a cored hole to its diameter does not reach a point that will result in excessive pin damage.
6. These values should be increased whenever compatible with desired design and good molding techniques.
7. Customer-Molder understanding is necessary prior to tooling.

# Standards & Practices of Plastics Molders

**Material**  
Polypropylene  
(PP)

*Note:* The *Commercial* values shown below represent common production tolerances at the most economical level. The *Fine* values represent closer tolerances that can be held but at a greater cost. Any addition of fillers will compromise physical properties and alter dimensional stability. Please consult the manufacturer.

Drawing Code	Dimensions (Inches)	Plus or Minus in Thousands of an Inch				
		5	10	15	20	25
A = Diameter (See note #1)	0.000	Commercial	Fine			
	0.500					
	1.000					
	2.000					
	3.000					
	4.000					
B = Depth (See note #3)	5.000					
	6.000					
C = Height (See note #3)	6.000 to 12.000 for each additional inch add (inches)	Comm. ±	Fine ±			
		0.005	0.003			
D = Bottom Wall	(See note #3)	0.006	0.003			
E = Side Wall	(See note #4)	0.006	0.003			
F = Hole Size Diameter (See note #1)	0.000 to 0.125	0.003	0.002			
	0.126 to 0.250	0.004	0.003			
	0.251 to 0.500	0.005	0.004			
	0.501 & over	0.008	0.006			
G = Hole Size Depth (See note #5)	0.000 to 0.250	0.005	0.003			
	0.251 to 0.500	0.006	0.004			
	0.501 to 1.000	0.009	0.006			
H = Corners, Ribs, Fillets	(See note #6)	0.029	0.016			
Flatness (See note #4)	0.000 to 3.000	0.022	0.014			
	3.001 to 6.000	0.036	0.021			
Thread Size (Class)	Internal	1	2			
	External	1	2			
Concentricity	(See note #4) (F.I.M.)	0.015	0.012			
Draft Allowance Per Side	(See note #5)	1.5°	0.5°			
Surface Finish	(See note #7)					
Color Stability	(See note #7)					

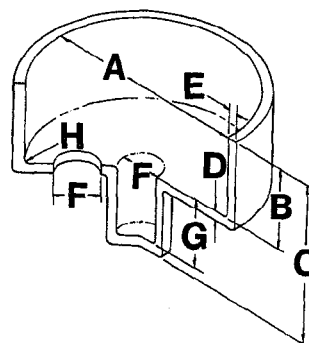

### REFERENCE NOTES

1. These tolerances do not include allowance for aging characteristics of material.
2. Tolerances are based on 0.125 inch wall section.
3. Parting line must be taken into consideration.
4. Part design should maintain a wall thickness as nearly constant as possible. Complete uniformity in this dimension is sometimes impossible to achieve. Walls of non-uniform thickness should be gradually blended from thick to thin.
5. Care must be taken that the ratio of the depth of a cored hole to its diameter does not reach a point that will result in excessive pin damage.
6. These values should be increased whenever compatible with desired design and good molding techniques.
7. Customer-Molder understanding is necessary prior to tooling.

# Standards & Practices of Plastics Molders

**Material**  
Polypropylene  
(PP)

*Note:* The *Commercial* values shown below represent common production tolerances at the most economical level. The *Fine* values represent closer tolerances that can be held but at a greater cost. Any addition of fillers will compromise physical properties and alter dimensional stability. Please consult the manufacturer.

Drawing Code	Dimensions (mm)	Plus or Minus in Thousands of an Millimeter									
		50	100	150	200	250	300	350	400	450	500
A = Diameter (See note #1)	0										
	25										
	50										
	75										
	100										
	125										
	150										
	150 to 300 for each additional 25 mm add (mm)	Comm. ±	Fine ±								
D = Bottom Wall	(See note #3)	0.155	0.075								
E = Side Wall	(See note #4)	0.155	0.075								
F = Hole Size Diameter (See note #1)	0.000 to 3.000	0.080	0.050								
	3.001 to 6.000	0.105	0.075								
	6.001 to 12.000	0.130	0.100								
	12.001 & over	0.205	0.150								
G = Hole Size Depth (See note #5)	0.000 to 6.000	0.130	0.075								
	6.001 to 12.000	0.155	0.100								
	12.001 to 25.000	0.230	0.150								
H = Corners, Ribs, Fillets	(See note #6)	0.735	0.405								
Flatness (See note #4)	0.000 to 75.000	0.560	0.355								
	75.001 to 150.000	0.915	0.530								
Thread Size (Class)	Internal	1	2								
	External	1	2								
Concentricity	(See note #4) (F.I.M.)	0.385	0.305								
Draft Allowance Per Side	(See note #5)	1.5°	0.5°								
Surface Finish	(See note #7)										
Color Stability	(See note #7)										

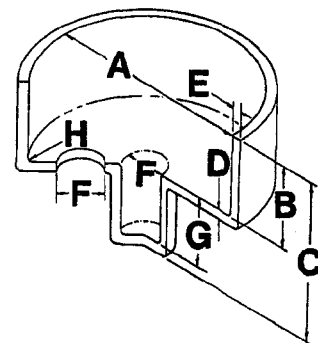

### REFERENCE NOTES

1. These tolerances do not include allowance for aging characteristics of material.
2. Tolerances are based on 3.175 mm wall section.
3. Parting line must be taken into consideration.
4. Part design should maintain a wall thickness as nearly constant as possible. Complete uniformity in this dimension is sometimes impossible to achieve. Walls of non-uniform thickness should be gradually blended from thick to thin.
5. Care must be taken that the ratio of the depth of a cored hole to its diameter does not reach a point that will result in excessive pin damage.
6. These values should be increased whenever compatible with desired design and good molding techniques.
7. Customer-Molder understanding is necessary prior to tooling.

# Standards & Practices of Plastics Molders

**Material**  
Polyphenylene Ether  
(PPE)

**Note:** The *Commercial* values shown below represent common production tolerances at the most economical level. The *Fine* values represent closer tolerances that can be held but at a greater cost. Any addition of fillers will compromise physical properties and alter dimensional stability. Please consult the manufacturer.

Drawing Code	Dimensions (Inches)	Plus or Minus in Thousands of an Inch				
		5	10	15	20	25
A = Diameter (See note #1)	0.000					
	0.500					
	1.000					
	2.000					
	3.000					
	4.000					
	5.000					
B = Depth (See note #2)	6.000					
	6.000 to 12.000 for each additional inch add (inches)	Comm. ±	Fine ±			
D = Bottom Wall	(See note #3)	0.001	0.0005			
E = Side Wall	(See note #6)	0.001	0.0005			
F = Hole Size Diameter	0.000 to 0.125	0.001	0.0005			
	0.126 to 0.250	0.001	0.0005			
	0.251 to 0.500	0.0015	0.001			
	0.501 & over	0.002	0.0015			
G = Hole Size Depth	0.000 to 0.250	0.001	0.0005			
	0.251 to 0.500	0.001	0.0005			
	0.501 to 1.000	0.0015	0.001			
H = Corners, Ribs, Fillets		0.005	0.005			
Flatness	0.000 to 3.000	0.010	0.007			
	3.001 to 6.000	0.020	0.014			
Thread Size (Class)	Internal					
	External					
Concentricity	(See note #4) (F.I.M.)	0.005	0.002			
Draft Allowance Per Side	(See note #7)	2.0°	0.5°			
Surface Finish	(See note #5)					
Color Stability	(See note #5)					

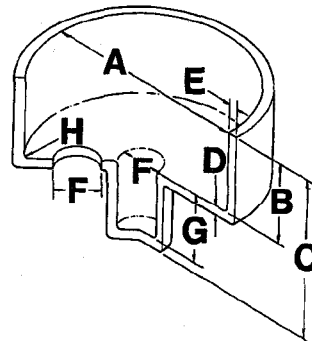

### REFERENCE NOTES

1. These tolerances do not include allowance for aging characteristics of material.
2. Tolerances do not apply to screw threads, gear teeth or match fits.
3. Parting line must be taken into consideration.
4. Part design should maintain a wall thickness as nearly constant as possible. Complete uniformity in this dimension is sometimes impossible to achieve. Walls of non-uniform thickness should be gradually blended from thick to thin.
5. Customer-Molder understanding is necessary prior to tooling.
6. This dimension is a function of mold design and construction.
7. These values should be considered minimum.

# Standards & Practices of Plastics Molders

**Material**  
Polyphenylene Ether  
(PPE)

*Note:* The *Commercial* values shown below represent common production tolerances at the most economical level. The *Fine* values represent closer tolerances that can be held but at a greater cost. Any addition of fillers will compromise physical properties and alter dimensional stability. Please consult the manufacturer.

Drawing Code	Dimensions (mm)	Plus or Minus in Thousands of an Millimeter									
		50	100	150	200	250	300	350	400	450	500
A = Diameter (See note #1)  B = Depth (See note #2)  C = Height (See note #2)	0										
	25										
	50										
	75										
	100										
	125										
	150										
	150 to 300 for each additional 25 mm add (mm)	Comm. ±	Fine ±								
D = Bottom Wall	(See note #3)	0.025	0.013								
E = Side Wall	(See note #6)	0.025	0.013								
F = Hole Size Diameter	0.000 to 3.000	0.025	0.013								
	3.001 to 6.000	0.025	0.013								
	6.001 to 12.000	0.038	0.025								
	12.001 & over	0.050	0.038								
G = Hole Size Depth	0.000 to 6.000	0.025	0.013								
	6.001 to 12.000	0.025	0.013								
	12.001 to 25.000	0.038	0.025								
H = Corners, Ribs, Fillets		0.127	0.127								
Flatness	0.000 to 75.000	0.254	0.180								
	75.001 to 150.000	0.508	0.356								
Thread Size (Class)	Internal										
	External										
Concentricity	(See note #4) (F.I.M.)	0.130	0.050								
Draft Allowance Per Side	(See note #7)	2.0°	0.5°								
Surface Finish	(See note #5)										
Color Stability	(See note #5)										

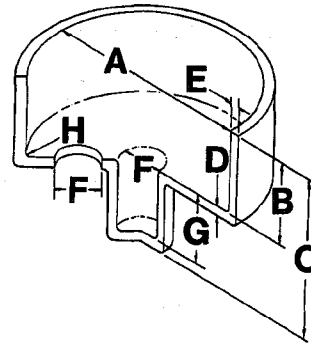

## REFERENCE NOTES

1. These tolerances do not include allowance for aging characteristics of material.
2. Tolerances do not apply to screw threads, gear teeth or match fits.
3. Parting line must be taken into consideration.
4. Part design should maintain a wall thickness as nearly constant as possible. Complete uniformity in this dimension is sometimes impossible to achieve. Walls of non-uniform thickness should be gradually blended from thick to thin.
5. Customer-Molder understanding is necessary prior to tooling.
6. This dimension is a function of mold design and construction.
7. These values should be considered minimum.

# Standards & Practices of Plastics Molders

**Material**  
Polyphenylene Oxide  
(PPO)

*Note:* The *Commercial* values shown below represent common production tolerances at the most economical level. The *Fine* values represent closer tolerances that can be held but at a greater cost. Any addition of fillers will compromise physical properties and alter dimensional stability. Please consult the manufacturer.

Drawing Code	Dimensions (Inches)	Plus or Minus in Thousands of an Inch				
		5	10	15	20	25
A = Diameter (See note #1)	0.000					
	0.500					
	1.000					
	2.000					
	3.000					
	4.000					
B = Depth (See note #2)	5.000					
	6.000					
C = Height (See note #2)	6.000 to 12.000 for each additional inch add (inches)	Comm. ±	Fine ±			
		0.001	0.0005			
D = Bottom Wall	(See note #3)	0.001	0.0005			
E = Side Wall	(See note #6)	0.001	0.0005			
F = Hole Size Diameter	0.000 to 0.125	0.001	0.0005			
	0.126 to 0.250	0.001	0.0005			
	0.251 to 0.500	0.0015	0.001			
	0.501 & over	0.002	0.0015			
G = Hole Size Depth	0.000 to 0.250	0.001	0.0005			
	0.251 to 0.500	0.001	0.0005			
	0.501 to 1.000	0.0015	0.001			
H = Corners, Ribs, Fillets		0.005	0.005			
Flatness	0.000 to 3.000	0.010	0.007			
	3.001 to 6.000	0.020	0.014			
Thread Size (Class)	Internal					
	External					
Concentricity	(See note #4) (F.I.M.)	0.005	0.002			
Draft Allowance Per Side	(See note #7)	2.0°	0.5°			
Surface Finish	(See note #5)					
Color Stability	(See note #5)					

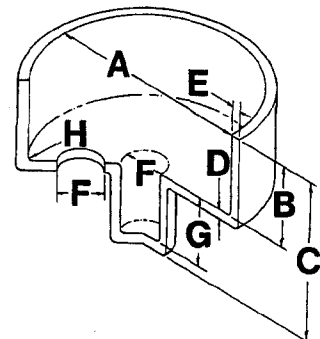

### REFERENCE NOTES

1. These tolerances do not include allowance for aging characteristics of material.
2. Tolerances do not apply to screw threads, gear teeth or match fits.
3. Parting line must be taken into consideration.
4. Part design should maintain a wall thickness as nearly constant as possible. Complete uniformity in this dimension is sometimes impossible to achieve. Walls of non-uniform thickness should be gradually blended from thick to thin.
5. Customer-Molder understanding is necessary prior to tooling.
6. This dimension is a function of mold design and construction.
7. These values should be considered *minimum*.

# Standards & Practices of Plastics Molders

**Material**  
Polyphenylene Oxide  
(PPO)

*Note:* The *Commercial* values shown below represent common production tolerances at the most economical level. The *Fine* values represent closer tolerances that can be held but at a greater cost. Any addition of fillers will compromise physical properties and alter dimensional stability. Please consult the manufacturer.

Drawing Code	Dimensions (mm)	Plus or Minus in Thousands of an Millimeter									
		50	100	150	200	250	300	350	400	450	500
A = Diameter (See note #1)  B = Depth (See note #2)  C = Height (See note #2)	0										
	25										
	50										
	75										
	100										
	125										
	150										
	150 to 300 for each additional 25 mm add (mm)	Comm. ±	Fine ±								
D = Bottom Wall	(See note #3)	0.025	0.013								
E = Side Wall	(See note #6)	0.025	0.013								
F = Hole Size Diameter	0.000 to 3.000	0.025	0.013								
	3.001 to 6.000	0.025	0.013								
	6.001 to 12.000	0.038	0.025								
	12.001 & over	0.050	0.038								
G = Hole Size Depth	0.000 to 6.000	0.025	0.013								
	6.001 to 12.000	0.025	0.013								
	12.001 to 25.000	0.038	0.025								
H = Corners, Ribs, Fillets		0.127	0.127								
Flatness	0.000 to 75.000	0.254	0.180								
	75.001 to 150.000	0.508	0.356								
Thread Size (Class)	Internal										
	External										
Concentricity	(See note #4) (F.I.M.)	0.130	0.050								
Draft Allowance Per Side	(See note #7)	2.0°	0.5°								
Surface Finish	(See note #5)										
Color Stability	(See note #5)										

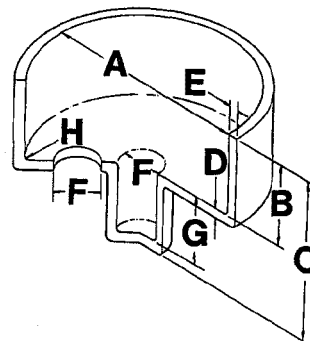

### REFERENCE NOTES

1. These tolerances do not include allowance for aging characteristics of material.
2. Tolerances do not apply to screw threads, gear teeth or match fits.
3. Parting line must be taken into consideration.
4. Part design should maintain a wall thickness as nearly constant as possible. Complete uniformity in this dimension is sometimes impossible to achieve. Walls of non-uniform thickness should be gradually blended from thick to thin.
5. Customer-Molder understanding is necessary prior to tooling.
6. This dimension is a function of mold design and construction.
7. These values should be considered minimum.



# Standards & Practices of Plastics Molders

**Material**  
Polystyrene  
(PS)

*Note:* The *Commercial* values shown below represent common production tolerances at the most economical level. The *Fine* values represent closer tolerances that can be held but at a greater cost. Any addition of fillers will compromise physical properties and alter dimensional stability. Please consult the manufacturer.

Drawing Code	Dimensions (Inches)	Plus or Minus in Thousands of an Inch				
		5	10	15	20	25
A = Diameter (See note #1)	0.000					
	0.500					
	1.000					
	2.000					
	3.000					
	4.000					
	5.000					
B = Depth (See note #3)	6.000					
	6.000 to 12.000 for each additional inch add (inches)	Comm. ±	Fine ±			
		0.004	0.002			
D = Bottom Wall	(See note #3)	0.006	0.003			
E = Side Wall	(See note #4)	0.007	0.003			
F = Hole Size Diameter (See note #1)	0.000 to 0.125	0.002	0.001			
	0.126 to 0.250	0.002	0.001			
	0.251 to 0.500	0.002	0.001			
	0.501 & over	0.004	0.002			
G = Hole Size Depth (See note #5)	0.000 to 0.250	0.004	0.002			
	0.251 to 0.500	0.004	0.002			
	0.501 to 1.000	0.005	0.003			
H = Corners, Ribs, Fillets	(See note #6)	0.015	0.010			
Flatness (See note #4)	0.000 to 3.000	0.007	0.004			
	3.001 to 6.000	0.013	0.005			
Thread Size (Class)	Internal	1	2			
	External	1	2			
Concentricity	(See note #4) (F.I.M.)	0.010	0.008			
Draft Allowance Per Side	(See note #5)	1.0°	0.5°			
Surface Finish	(See note #7)					
Color Stability	(See note #7)					

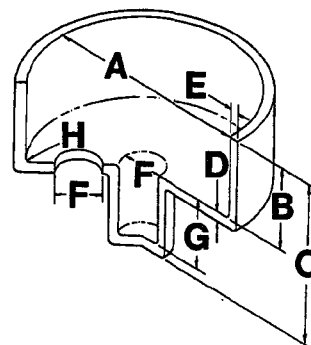

### REFERENCE NOTES

1. These tolerances do not include allowance for aging characteristics of material.
2. Tolerances are based on 0.125 inch wall section.
3. Parting line must be taken into consideration.
4. Part design should maintain a wall thickness as nearly constant as possible. Complete uniformity in this dimension is sometimes impossible to achieve. Walls of non-uniform thickness should be gradually blended from thick to thin.
5. Care must be taken that the ratio of the depth of a cored hole to its diameter does not reach a point that will result in excessive pin damage.
6. These values should be increased whenever compatible with desired design and good molding techniques.
7. Customer-Molder understanding is necessary prior to tooling.

# Standards & Practices of Plastics Molders

**Material**  
Polystyrene  
(PS)

*Note:* The *Commercial* values shown below represent common production tolerances at the most economical level. The *Fine* values represent closer tolerances that can be held but at a greater cost. Any addition of fillers will compromise physical properties and alter dimensional stability. Please consult the manufacturer.

Drawing Code	Dimensions (mm)	Plus or Minus in Thousands of an Millimeter									
		50	100	150	200	250	300	350	400	450	500
A = Diameter (See note #1)	0										
	25										
	50										
	75										
	100										
	125										
B = Depth (See note #3)	150										
	150 to 300 for each additional 25 mm add (mm)	Comm. ±	Fine ±								
D = Bottom Wall	(See note #3)	0.155	0.075								
E = Side Wall	(See note #4)	0.180	0.075								
F = Hole Size Diameter (See note #1)	0.000 to 3.000	0.055	0.025								
	3.001 to 6.000	0.055	0.025								
	6.001 to 12.000	0.055	0.025								
	12.001 & over	0.105	0.050								
G = Hole Size Depth (See note #5)	0.000 to 6.000	0.105	0.050								
	6.001 to 12.000	0.105	0.050								
	12.001 to 25.000	0.130	0.075								
H = Corners, Ribs, Fillets	(See note #6)	0.385	0.250								
Flatness (See note #4)	0.000 to 75.000	0.180	0.100								
	75.001 to 150.000	0.330	0.125								
Thread Size (Class)	Internal	1	2								
	External	1	2								
Concentricity	(See note #4) (F.I.M.)	0.255	0.200								
Draft Allowance Per Side	(See note #5)	1.0°	0.5°								
Surface Finish	(See note #7)										
Color Stability	(See note #7)										

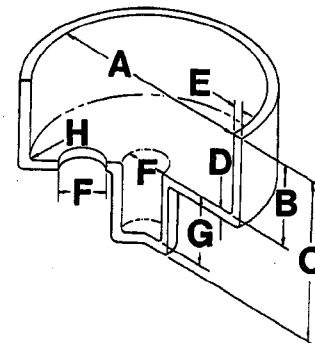

### REFERENCE NOTES

1. These tolerances do not include allowance for aging characteristics of material.
2. Tolerances are based on 3.175 mm wall section.
3. Parting line must be taken into consideration.
4. Part design should maintain a wall thickness as nearly constant as possible. Complete uniformity in this dimension is sometimes impossible to achieve. Walls of non-uniform thickness should be gradually blended from thick to thin.
5. Care must be taken that the ratio of the depth of a cored hole to its diameter does not reach a point that will result in excessive pin damage.
6. These values should be increased whenever compatible with desired design and good molding techniques.
7. Customer-Molder understanding is necessary prior to tooling.

# Standards & Practices of Plastics Molders

**Material**  
Polyvinyl Chloride (PVC)  
(Vinyl) (Flexible)

*Note:* The *Commercial* values shown below represent common production tolerances at the most economical level. The *Fine* values represent closer tolerances that can be held but at a greater cost. Any addition of fillers will compromise physical properties and alter dimensional stability. Please consult the manufacturer.

Drawing Code	Dimensions (Inches)	Plus or Minus in Thousands of an Inch				
		5	10	15	20	25
A = Diameter (See note #1)	0.000					
	0.500					
	1.000					
	2.000					
	3.000					
	4.000					
B = Depth (See note #3)	5.000					
	6.000					
C = Height (See note #3)	6.000 to 12.000 for each additional inch add (inches)	Comm. ±	Fine ±			
		0.005	0.003			
D = Bottom Wall	(See note #3)	0.007	0.003			
E = Side Wall	(See note #4)	0.007	0.003			
F = Hole Size Diameter (See note #1)	0.000 to 0.125	0.004	0.003			
	0.126 to 0.250	0.005	0.004			
	0.251 to 0.500	0.006	0.005			
	0.501 & over	0.008	0.006			
G = Hole Size Depth (See note #5)	0.000 to 0.250	0.004	0.003			
	0.251 to 0.500	0.005	0.004			
	0.501 to 1.000	0.006	0.005			
H = Corners, Ribs, Fillets	(See note #6)	0.030	0.010			
Flatness (See note #4)	0.000 to 3.000	0.010	0.007			
	3.001 to 6.000	0.020	0.015			
Thread Size (Class)	Internal					
	External					
Concentricity	(See note #4) (F.I.M.)	0.015	0.010			
Draft Allowance Per Side	(See note #5)	1.5°	1.0°			
Surface Finish	(See note #7)					
Color Stability	(See note #7)					

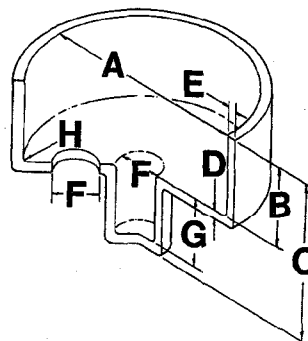

## REFERENCE NOTES

1. These tolerances do not include allowance for aging characteristics of material.
2. Tolerances are based on 0.125 inch wall section.
3. Parting line must be taken into consideration.
4. Part design should maintain a wall thickness as nearly constant as possible. Complete uniformity in this dimension is sometimes impossible to achieve. Walls of non-uniform thickness should be gradually blended from thick to thin.
5. Care must be taken that the ratio of the depth of a cored hole to its diameter does not reach a point that will result in excessive pin damage.
6. These values should be increased whenever compatible with desired design and good molding techniques.
7. Customer-Molder understanding is necessary prior to tooling.

# Standards & Practices of Plastics Molders

**Material**  
Polyvinyl Chloride (PVC)  
(Vinyl) (Flexible)

*Note:* The *Commercial* values shown below represent common production tolerances at the most economical level. The *Fine* values represent closer tolerances that can be held but at a greater cost. Any addition of fillers will compromise physical properties and alter dimensional stability. Please consult the manufacturer.

Drawing Code	Dimensions (mm)	Plus or Minus in Thousands of an Millimeter										
		50	100	150	200	250	300	350	400	450	500	
A = Diameter (See note #1)	0											
	25											
	50											
	75											
	100											
	125											
	150											
	150 to 300 for each additional 25 mm add (mm)	Comm. ±	Fine ±									
		0.130	0.075									
D = Bottom Wall	(See note #3)	0.180	0.075									
E = Side Wall	(See note #4)	0.180	0.075									
F = Hole Size Diameter (See note #1)	0.000 to 3.000	0.105	0.075									
	3.001 to 6.000	0.130	0.100									
	6.001 to 12.000	0.155	0.125									
	12.001 & over	0.205	0.150									
G = Hole Size Depth (See note #5)	0.000 to 6.000	0.105	0.075									
	6.001 to 12.000	0.130	0.100									
	12.001 to 25.000	0.155	0.125									
H = Corners, Ribs, Fillets	(See note #6)	0.765	0.250									
Flatness (See note #4)	0.000 to 75.000	0.255	0.175									
	75.001 to 150.000	0.510	0.380									
Thread Size (Class)	Internal											
	External											
Concentricity	(See note #4) (F.I.M.)	0.385	0.250									
Draft Allowance Per Side	(See note #5)	1.5°	1.0°									
Surface Finish	(See note #7)											
Color Stability	(See note #7)											

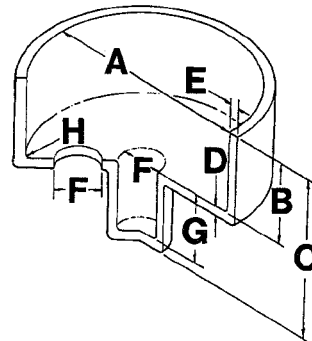

### REFERENCE NOTES

1. These tolerances do not include allowance for aging characteristics of material.
2. Tolerances are based on 3.175 mm wall section.
3. Parting line must be taken into consideration.
4. Part design should maintain a wall thickness as nearly constant as possible. Complete uniformity in this dimension is sometimes impossible to achieve. Walls of non-uniform thickness should be gradually blended from thick to thin.
5. Care must be taken that the ratio of the depth of a cored hole to its diameter does not reach a point that will result in excessive pin damage.
6. These values should be increased whenever compatible with desired design and good molding techniques.
7. Customer-Molder understanding is necessary prior to tooling.

# Standards & Practices of Plastics Molders

**Material**  
Polyvinyl Chloride (PVC)  
(Vinyl) (Rigid)

*Note:* The *Commercial* values shown below represent common production tolerances at the most economical level. The *Fine* values represent closer tolerances that can be held but at a greater cost. Any addition of fillers will compromise physical properties and alter dimensional stability. Please consult the manufacturer.

Drawing Code	Dimensions (Inches)	Plus or Minus in Thousands of an Inch				
		5	10	15	20	25
A = Diameter (See note #1)	0.000					
	0.500					
	1.000					
	2.000					
	3.000					
	4.000					
	5.000					
B = Depth (See note #3)	6.000					
	6.000 to 12.000 for each additional inch add (inches)	Comm. ± 0.005	Fine ± 0.003			
D = Bottom Wall	(See note #3)	0.007	0.003			
E = Side Wall	(See note #4)	0.007	0.003			
F = Hole Size Diameter (See note #1)	0.000 to 0.125	0.004	0.003			
	0.126 to 0.250	0.004	0.003			
	0.251 to 0.500	0.005	0.004			
	0.501 & over	0.006	0.005			
G = Hole Size Depth (See note #5)	0.000 to 0.250	0.004	0.003			
	0.251 to 0.500	0.005	0.004			
	0.501 to 1.000	0.006	0.005			
H = Corners, Ribs, Fillets	(See note #6)	0.035	0.030			
Flatness (See note #4)	0.000 to 3.000	0.015	0.010			
	3.001 to 6.000	0.020	0.015			
Thread Size (Class)	Internal	1	2			
	External	1	2			
Concentricity	(See note #4) (F.I.M.)	0.010	0.005			
Draft Allowance Per Side	(See note #5)	1.0°	0.5°			
Surface Finish	(See note #7)					
Color Stability	(See note #7)					

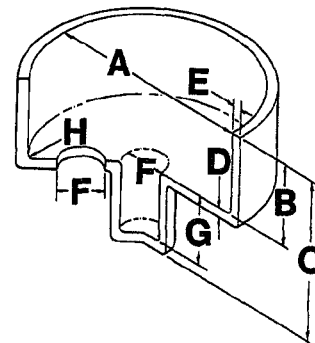

## REFERENCE NOTES

1. These tolerances do not include allowance for aging characteristics of material.
2. Tolerances are based on 0.125 inch wall section.
3. Parting line must be taken into consideration.
4. Part design should maintain a wall thickness as nearly constant as possible. Complete uniformity in this dimension is sometimes impossible to achieve. Walls of non-uniform thickness should be gradually blended from thick to thin.
5. Care must be taken that the ratio of the depth of a cored hole to its diameter does not reach a point that will result in excessive pin damage.
6. These values should be increased whenever compatible with desired design and good molding techniques.
7. Customer-Molder understanding is necessary prior to tooling.

# Standards & Practices of Plastics Molders

**Material**  
Polyvinyl Chloride (PVC)  
(Vinyl) (Rigid)

*Note:* The *Commercial* values shown below represent common production tolerances at the most economical level. The *Fine* values represent closer tolerances that can be held but at a greater cost. Any addition of fillers will compromise physical properties and alter dimensional stability. Please consult the manufacturer.

Drawing Code	Dimensions (mm)	Plus or Minus in Thousands of an Millimeter									
		50	100	150	200	250	300	350	400	450	500
A = Diameter (See note #1)	0										
	25										
	50										
	75										
	100										
	125										
	150										
	150 to 300 for each additional 25 mm add (mm)	Comm. ±	Fine ±								
D = Bottom Wall	(See note #3)	0.130	0.075								
E = Side Wall	(See note #4)	0.180	0.075								
F = Hole Size Diameter (See note #1)	0.000 to 3.000	0.105	0.075								
	3.001 to 6.000	0.105	0.075								
	6.001 to 12.000	0.130	0.100								
	12.001 & over	0.155	0.125								
G = Hole Size Depth (See note #5)	0.000 to 6.000	0.105	0.075								
	6.001 to 12.000	0.130	0.100								
	12.001 to 25.000	0.155	0.125								
H = Corners, Ribs, Fillets	(See note #6)	0.890	0.760								
Flatness (See note #4)	0.000 to 75.000	0.385	0.250								
	75.001 to 150.000	0.510	0.380								
Thread Size (Class)	Internal	1	2								
	External	1	2								
Concentricity	(See note #4) (F.I.M.)	0.255	0.125								
Draft Allowance Per Side	(See note #5)	1.0°	0.5°								
Surface Finish	(See note #7)										
Color Stability	(See note #7)										

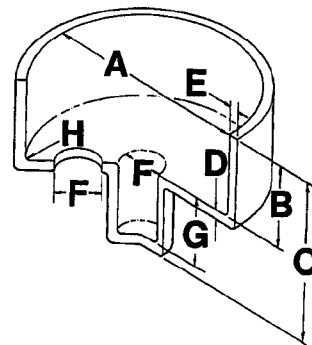

### REFERENCE NOTES

1. These tolerances do not include allowance for aging characteristics of material.
2. Tolerances are based on 3.175 mm wall section.
3. Parting line must be taken into consideration.
4. Part design should maintain a wall thickness as nearly constant as possible. Complete uniformity in this dimension is sometimes impossible to achieve. Walls of non-uniform thickness should be gradually blended from thick to thin.
5. Care must be taken that the ratio of the depth of a cored hole to its diameter does not reach a point that will result in excessive pin damage.
6. These values should be increased whenever compatible with desired design and good molding techniques.
7. Customer-Molder understanding is necessary prior to tooling.

# Standards & Practices of Plastics Molders

**Material**  
Styrene-Acrylonitrile  
(SAN)

*Note:* The *Commercial* values shown below represent common production tolerances at the most economical level. The *Fine* values represent closer tolerances that can be held but at a greater cost. Any addition of fillers will compromise physical properties and alter dimensional stability. Please consult the manufacturer.

Drawing Code	Dimensions (Inches)	Plus or Minus in Thousands of an Inch				
		5	10	15	20	25
A = Diameter (See note #1)	0.000					
	0.500					
	1.000					
	2.000					
	3.000					
	4.000					
B = Depth (See note #3)	2.000					
C = Height (See note #3)	3.000					
	4.000					
	5.000					
	6.000					
	6.000 to 12.000 for each additional inch add (inches)	Comm. ±	Fine ±			
		0.002	0.0015			
D = Bottom Wall	(See note #3)	0.003	0.0015			
E = Side Wall	(See note #4)	0.002	0.0015			
F = Hole Size Diameter (See note #1)	0.000 to 0.125	0.002	0.001			
	0.126 to 0.250	0.002	0.001			
	0.251 to 0.500	0.003	0.0015			
	0.501 & over	0.003	0.0015			
G = Hole Size Depth (See note #5)	0.000 to 0.250	0.002	0.001			
	0.251 to 0.500	0.003	0.002			
	0.501 to 1.000	0.003	0.002			
H = Corners, Ribs, Fillets	(See note #6)	0.030	0.025			
Flatness (See note #4)	0.000 to 3.000	0.012	0.009			
	3.001 to 6.000					
Thread Size (Class)	Internal					
	External					
Concentricity	(See note #4) (F.I.M.)					
Draft Allowance Per Side	(See note #5)	2.0°	1.5°			
Surface Finish	(See note #7)					
Color Stability	(See note #7)					

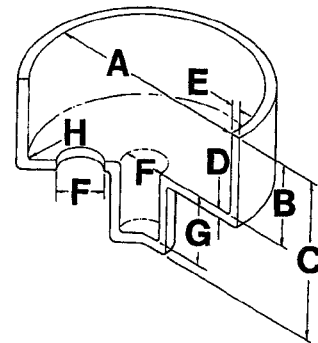

## REFERENCE NOTES

1. These tolerances do not include allowance for aging characteristics of material.
2. Tolerances are based on 0.125 inch wall section.
3. Parting line must be taken into consideration.
4. Part design should maintain a wall thickness as nearly constant as possible. Complete uniformity in this dimension is sometimes impossible to achieve. Walls of non-uniform thickness should be gradually blended from thick to thin.
5. Care must be taken that the ratio of the depth of a cored hole to its diameter does not reach a point that will result in excessive pin damage.
6. These values should be increased whenever compatible with desired design and good molding techniques.
7. Customer-Molder understanding is necessary prior to tooling.

# Standards & Practices of Plastics Molders

**Material**  
Styrene-Acrylonitrile  
(SAN)

*Note:* The *Commercial* values shown below represent common production tolerances at the most economical level. The *Fine* values represent closer tolerances that can be held but at a greater cost. Any addition of fillers will compromise physical properties and alter dimensional stability. Please consult the manufacturer.

Drawing Code	Dimensions (mm)	Plus or Minus in Thousands of an Millimeter									
		50	100	150	200	250	300	350	400	450	500
A = Diameter (See note #1)  B = Depth (See note #3)  C = Height (See note #3)	0										
	25										
	50										
	75										
	100										
	125										
	150										
	150 to 300 for each additional 25 mm add (mm)	Comm. ±	Fine ±								
D = Bottom Wall	(See note #3)	0.075	0.038								
E = Side Wall	(See note #4)	0.055	0.038								
F = Hole Size Diameter (See note #1)	0.000 to 3.000	0.050	0.025								
	3.001 to 6.000	0.050	0.025								
	6.001 to 12.000	0.075	0.038								
	12.001 & over	0.080	0.038								
G = Hole Size Depth (See note #5)	0.000 to 6.000	0.050	0.025								
	6.001 to 12.000	0.080	0.050								
	12.001 to 25.000	0.075	0.050								
H = Corners, Ribs, Fillets	(See note #6)	0.762	0.635								
Flatness (See note #4)	0.000 to 75.000	0.305	0.229								
	75.001 to 150.000										
Thread Size (Class)	Internal										
	External										
Concentricity	(See note #4) (F.I.M.)										
Draft Allowance Per Side	(See note #5)	2.0°	1.5°								
Surface Finish	(See note #7)										
Color Stability	(See note #7)										

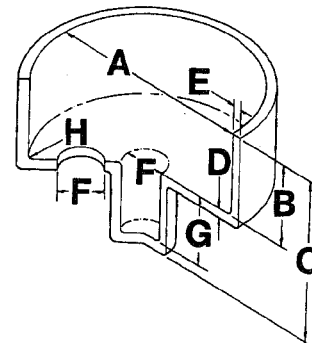

### REFERENCE NOTES

1. These tolerances do not include allowance for aging characteristics of material.
2. Tolerances are based on 3.175 mm wall section.
3. Parting line must be taken into consideration.
4. Part design should maintain a wall thickness as nearly constant as possible. Complete uniformity in this dimension is sometimes impossible to achieve. Walls of non-uniform thickness should be gradually blended from thick to thin.
5. Care must be taken that the ratio of the depth of a cored hole to its diameter does not reach a point that will result in excessive pin damage.
6. These values should be increased whenever compatible with desired design and good molding techniques.
7. Customer-Molder understanding is necessary prior to tooling.



# Standards & Practices of Plastics Molders

**Material**  
Thermoplastic Polyester  
(TPPE)

*Note:* The *Commercial* values shown below represent common production tolerances at the most economical level. The *Fine* values represent closer tolerances that can be held but at a greater cost. Any addition of fillers will compromise physical properties and alter dimensional stability. Please consult the manufacturer.

Drawing Code	Dimensions (Inches)	Plus or Minus in Thousands of an Inch (See note #5)				
		5	10	15	20	25
<b>A = Diameter</b> (See note #1)  <b>B = Depth</b> (See note #3)  <b>C = Height</b> (See note #3)	0.000					
	0.500					
	1.000					
	2.000					
	3.000					
	4.000					
	5.000					
	6.000					
	6.000 to 12.000 for each additional inch add (inches)	Comm. ±	Fine ±			
		0.0015	0.001			
<b>D = Bottom Wall</b>	(See note #3)	0.002	0.0015			
<b>E = Side Wall</b>	(See note #4)	0.002	0.0015			
<b>F = Hole Size Diameter</b>	0.000 to 0.125	0.001	0.0007			
	0.126 to 0.250	0.001	0.0007			
	0.251 to 0.500	0.001	0.0007			
	0.501 & over	0.0015	0.001			
<b>G = Hole Size Depth</b>	0.000 to 0.250	0.001	0.0007			
	0.251 to 0.500	0.001	0.0007			
	0.501 to 1.000	0.0015	0.001			
<b>H = Corners, Ribs, Fillets</b>	0.025 to 0.062	0.005	0.005			
	Flatness (See note #4)	0.000 to 3.000	0.006	0.004		
	3.001 to 6.000	0.010	0.006			
<b>Thread Size (Class)</b>	Internal					
	External					
<b>Concentricity</b>	(See note #2) (F.I.M.)					
<b>Draft Allowance Per Side</b>	(See note #6)	0.5°	0.25°			
<b>Surface Finish</b>	(See note #7)					
<b>Color Stability</b>	(See note #7)					

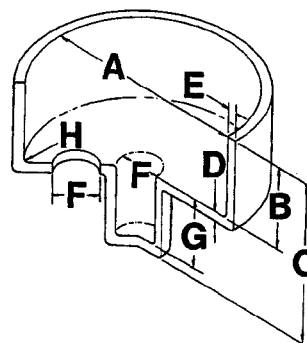

### REFERENCE NOTES

1. These tolerances do not include allowance for aging characteristics of material.
2. This dimension is a function of mold design and construction.
3. Parting line must be taken into consideration.
4. Part design should maintain a wall thickness as nearly constant as possible. Complete uniformity in this dimension is sometimes impossible to achieve. Walls of non-uniform thickness should be gradually blended from thick to thin.
5. These tolerances do not apply to screw threads, gear teeth or match fits. Provisions can usually be made to hold this type of dimension to close limits.
6. These values should be considered minimum. The designer should allow as much draft as is compatible with the design. Liberal use of draft will minimize ejection problems, and reduce distortion due to ejection.
7. Customer-Molder understanding is necessary prior to tooling.

# Standards & Practices of Plastics Molders

**Material**  
Thermoplastic Polyester  
(TPPE)

*Note:* The *Commercial* values shown below represent common production tolerances at the most economical level. The *Fine* values represent closer tolerances that can be held but at a greater cost. Any addition of fillers will compromise physical properties and alter dimensional stability. Please consult the manufacturer.

Drawing Code	Dimensions (mm)	Plus or Minus in Thousands of an Millimeter (See note #5)												
		50	100	150	200	250	300	350	400	450	500			
A = Diameter (See note #1)  B = Depth (See note #3)  C = Height (See note #3)	0													
	25													
	50													
	75													
	100													
	125													
	150													
	150 to 300 for each additional 25 mm add (mm)	Comm. ±	Fine ±											
D = Bottom Wall	(See note #3)	0.050	0.038											
E = Side Wall	(See note #4)	0.050	0.038											
F = Hole Size Diameter	0.000 to 3.000	0.025	0.018											
	3.001 to 6.000	0.025	0.018											
	6.001 to 12.000	0.025	0.018											
	12.001 & over	0.038	0.025											
G = Hole Size Depth	0.000 to 6.000	0.025	0.018											
	6.001 to 12.000	0.025	0.018											
	12.001 to 25.000	0.038	0.025											
H = Corners, Ribs, Fillets	0.660-1.600	0.013	0.013											
Flatness  (See note #4)	0.000 to 75.000	0.152	0.100											
	75.001 to 150.000	0.254	0.152											
Thread Size (Class)	Internal													
	External													
Concentricity	(See note #2) (F.I.M.)													
Draft Allowance Per Side	(See note #6)	0.5°	0.25°											
Surface Finish	(See note #7)													
Color Stability	(See note #7)													

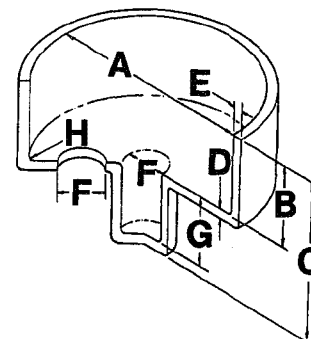

### REFERENCE NOTES

1. These tolerances do not include allowance for aging characteristics of material.
2. This dimension is a function of mold design and construction.
3. Parting line must be taken into consideration.
4. Part design should maintain a wall thickness as nearly constant as possible. Complete uniformity in this dimension is sometimes impossible to achieve. Walls of non-uniform thickness should be gradually blended from thick to thin.
5. These tolerances do not apply to screw threads, gear teeth or match fits. Provisions can usually be made to hold this type of dimension to close limits.
6. These values should be considered minimum. The designer should allow as much draft as is compatible with the design. Liberal use of draft will minimize ejection problems, and reduce distortion due to ejection.
7. Customer-Molder understanding is necessary prior to tooling.

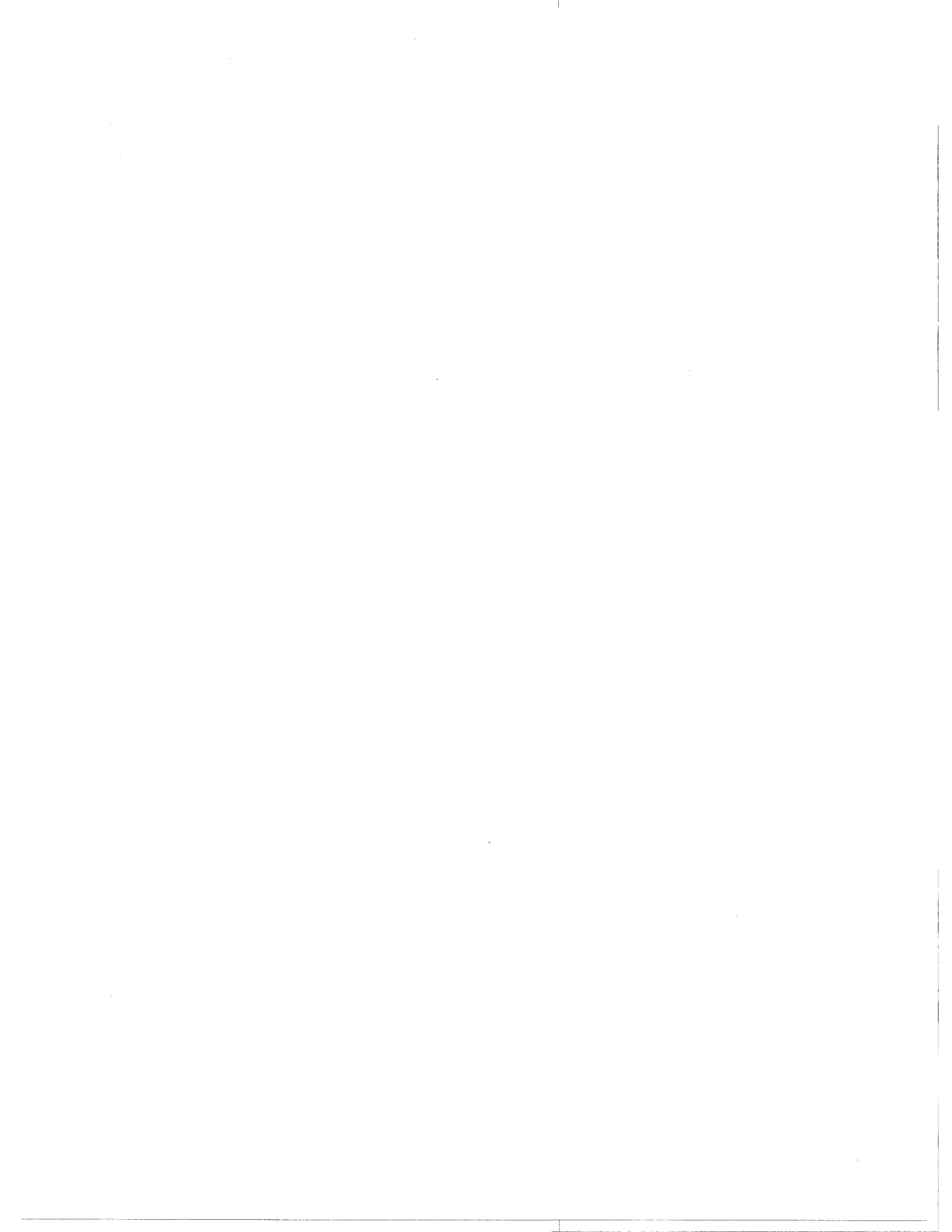

**Glossary of Terms**

This glossary of terms is published for the convenience of plastics molders and their customers by the Molders Division of The Society of the Plastics Industry.

**a**

A-STAGE - See THERMOSET

ABSORPTION and ADSORPTION - See MOISTURE.

ACCUMULATOR - (a) A device for conserving energy in hydraulic systems of molding equipment. (b) An auxiliary ram extruder used to provide fast material delivery in a molding machine.

ADDITIVE - A material added to resin prior to its being molded or formed to add a desired property or characteristic to the finished product.

ADIABATIC - Referring to any change in which there is no gain or loss of heat.

AGING - The change of a material with time under defined natural or synthetic environmental conditions, leading to improvement or deterioration of properties. Accelerated aging is a means whereby deterioration is reproduced in the laboratory in a shorter period of time.

ALLOY - Composite material made by blending polymers or copolymers with other polymers or elastomers under selected conditions, e.g., styrene-acrylonitrile copolymer resins blended, with butadiene-acrylonitrile rubbers.

ALPHA-CELLULOSE - A very pure cellulose used as a filler, particularly with amino plastics resins.

AMBIENT TEMPERATURE - Temperature of the medium surrounding an object. Used to denote prevailing room temperature.

AMINO - Indicates the presence of an - NH<sub>2</sub> or - NH group.

AMORPHOUS - Devoid of crystallinity.

ANGLE PRESS - A hydraulic molding press equipped with horizontal and vertical rams, and specially designed for the production of complex moldings containing deep undercuts.

ANNEAL - (1) To heat a molded plastic article to a predetermined temperature and slowly cool it, to relieve stresses. (2) To heat steel to a predetermined temperature above the critical range and slowly cool it, to relieve stresses and reduce hardness. (Annealing of molded or machined parts may be done dry, as in an oven, or wet, as in a heated tank of mineral oil.)

ANTIOXIDANT - A substance added in a material to inhibit oxidation.

ANTISTATIC AGENTS (ANTISTATS) - Agents which, when added to the molding material or applied on the surface of the molded part, make it less conducting (thus hindering the fixation of dust).

ARTIFICIAL AGING - The accelerated testing of plastic specimens to determine their changes in properties. Carried out over a short period of time, such tests are indicative of what may be expected of a material under service conditions over extended periods. Typical investigations include those for dimensional stability; the effect of immersion in water, chemicals and solvents; light stability; and resistance to fatigue.

ASTM - Abbreviation for American Society for Testing and Materials.

AUTOClave MOLDING - A modification of Pressure Bag molding in which the entire reinforced plastic layer is placed in a steam heated vessel.

**AUTOMATIC MOLD** - A mold for injection, compression or transfer molding that repeatedly goes through the entire molding cycle, including ejection, without human assistance.

### **b**

**B-STAGE** - See THERMOSET

**BACK PRESSURE** - (1) A pressure against the free flow of material during extruder running (plasticating) which causes the material to have a high mixing action. This pressure comes from the material resisting the forward movement of the material in the extruder or an externally controlled hydraulic pressure put against the movement of the extruder in a reciprocation screw machine to create this greater mixing action. (2) Resistance of a material, because of its viscosity, to continue flow when mold is closing.

**BACK TAPER - (BACK DRAFT)** Reverse draft used in mold to prevent molded articles from drawing freely. (UNDERCUT, REVERSE DRAFT, COUNTERDRAFT)

**BACKING PLATE** - In mold construction, a plate used as a support for the cavity blocks, guide pins, bushings, etc. (SUPPORT PLATE)

**BAG MOLDING** - A method of applying pressure or vacuum during molding, using a flexible membrane in contact with the product.

**BAKELITE** - A commercial name for phenolic and other plastics materials, often used indiscriminately to describe any phenolic molding material or molding. The name is derived from that of Dr. Leo Hendrik Baekeland (1863-1944), a Belgian who developed phenolic resins in the early 1900's. Bakelite is now owned by Union Carbide.

**BANANA GATE** - Curved shape that wraps over or under the part with a curved shape that will break away from the part like a tunnel gate.

**BARREL - (EXTRUDER)** In injection molding, extrusion or bottle blowing equipment, it is the hollow tube in which the plastic material is gradually heated and melted and from which it is extruded.

**BISCUIT - (PREFORM).**

**BLEED** - (1) To give up color when in contact with water or a solvent. (2) Undesired movement of certain materials in a plastic (e.g. plasticizers in vinyl) to the surface of the finished article or into an adjacent material. Also called "Migration." (3) An escape passage at the parting line of a mold, like a vent, but deeper, which allows material to escape or bleed out.

**BLISTER** - A raised area on the surface of a molded part caused by the pressure of gases or air inside it or in an incompletely hardened part surface.

**BLOOM** - A visible exudation or efflorescence on the surface of a plastic. Bloom can be caused by lubricant, plasticizer, etc. See LUBRICANT BLOOM.

**BLOW MOLDING** - (1) A molding process primarily used to produce hollow objects. (2) A molding process in which a hollow tube (parison) is forced into a shape of the mold cavity using internal air pressure. There are two primary types: Injection Blow Molding and Extrusion Blow Molding.

**BLOW PIN** - A hollow pin which is inserted or made to contact the blowing mold so that the blowing media can be introduced into the parison or hollow form and expand it to conform to the mold cavity.

**BLOW PRESSURE** - The pressure (internal) used to form a hollow part by Blow Molding.

**BLOW RATE** - The speed or rate that the blowing air or media enters or the time required to expand the parison (tube) or form during the blow molding cycle.

**BLOW-UP RATIO** - The ratio of the mold cavity diameter to the diameter of the parison or hollow form to be blown up. (SIMILAR TO DRAW DOWN RATIO.)

**BLOWING AGENTS** (foaming agents) - An additive which is capable of producing a cellular structure in a plastics or rubber mass. **GASEOUS BLOWING AGENT** - A compressed gas, such as compressed air or nitrogen, which is used to create a cellular structure or controlled voids in a rubber or plastics mass.

**BLUEING OFF** - The checking of the accuracy of mold cutoff surfaces by putting a thin coating of Prussian Blue on one-half and checking the blue transfer to the other half.

**BLUSH** - A term used to describe the tendency of a plastic to turn white or chalky in areas that are highly stressed: i.e. GATE BLUSH.

**BMC** - Bulk Molding Compound; a puttylike mixture of thermoset resin with initiator(s), fillers, reinforcement and other additives.

**BOLSTER** - Spacer or filler in a mold.

**BOSS** - Projection on a plastic part designed to add strength, to facilitate alignment during assembly, to provide for fastening, etc.

**BOTTOM PLATE** - Part of the mold which contains the heel radius and the push-up.

**BREAKER PLATE** - A perforated plate located at the end of an extruder or at the nozzle end of an injection cylinder. It often supports the screens that prevent foreign particles from entering the die, and is used to keep unplasticized material out of the nozzle and to improve distribution of color particles.

**BREATHING** - The opening and closing of a mold to allow gases to escape early in the molding cycle. Also called degassing. When referring to plastic sheeting, "breathing" indicates permeability to air.

**BRINELL HARDNESS** - Similar to ROCKWELL HARDNESS (q.v.).

**BUBBLE** - A spherical, internal void; globule of air or other gas trapped within a plastic. See VOID.

**BUBBLER** - A device inserted into a mold face, cavity or core, which allows water to flow deep inside the hole into which it is inserted and to discharge through the open end of the hole. Uniform cooling of the molds and of isolated mold sections can be achieved in this manner.

**BULK DENSITY** - The density of a molding material in loose form (granular, nodular, etc.) expressed as a ratio of weight to volume (e.g., g/cm<sup>3</sup> or lb/ft<sup>3</sup>).

**BULK FACTOR** - Ratio of the volume of loose molding powder to the volume of the same weight of resin after molding.

**BURNED** - Showing evidence of thermal decomposition through some discoloration, distortion, or localized destruction of the surface of the plastic. (BURN, BURN MARK)

## C

**C-STAGE** - See THERMOSET

**CAPROLACTAM** - A cyclic amide type compound, containing 6 carbon atoms. When the ring is opened, caprolactam is polymerizable into a nylon resin known as type-6 nylon or polycaprolactam.

**CARBON BLACK** - A black pigment produced by the incomplete burning of natural gas or oil. It is widely used as a filler, particularly in the rubber industry, and wire/cable applications. Because it possesses useful ultraviolet protective properties, it is also much used in molding compounds intended for outside weathering applications.

**CASE HARDEN** - To harden the surface of a piece of steel to a relatively shallow depth.

**CAST** - To form a "plastic" object by pouring or injecting a fluid monomer-polymer or using a plastic mixture which solidifies into an open mold where it finishes polymerizing.

**CAVITY** - Depression in mold, which usually forms the outer surface of the molded part; depending on number of such depressions, molds are designated as a single cavity mold, a multi-cavity mold, or a family cavity mold.

**CAVITY RETAINER PLATE** - Plates in a mold which hold the cavities. These plates are at the mold parting line and usually contain the guide pins and bushings.

**CELLULAR PLASTICS** - Foamed plastics.

**CELLULOSE** - A natural high polymeric carbohydrate found in most animal and plant life and a building block for natural and synthetic cellulose plastics.

**CENTER GATED MOLD** - An injection or transfer mold wherein the cavity is filled with molding material through a sprue or gate directly into the center of the part.

**CENTRIFUGAL MOLDING or CASTING** - See **ROTATIONAL MOLDING**.

**CHALKING** - Dry, chalk-like appearance or deposit on the surface of a plastic. See **HAZE** and **BLOOM**.

**CHARGE** - The measurement or weight of material used to load a mold at one time or during one cycle.

**CHARPY** - A type of pendulum **IMPACT** test for toughness.

**CHASE** - An enclosure of any shape, used to: (a) shrink-fit parts of a mold cavity in place; (b) prevent spreading or distortion in hobbing; (c) enclose an assembly of two or more parts of a split cavity block.

**CHEMICAL RESISTANCE** - Ability of a material to retain utility and appearance following contact with chemical agents.

**CHROMIUM PLATING** - An electrolytic process that deposits a hard film of chromium metal onto working surfaces of other metals where resistance to corrosion, abrasion, and/or erosion is needed.

**CLAMPING AREA** - The largest rated molding area an injection or transfer press can hold closed under full molding pressure.

**CLAMPING FORCE (CLAMPING PRESSURE)** - In injection molding and in transfer molding, the pressure which is applied to the mold to keep it closed against the fluid pressure of the compressed molding material within the mold cavity (cavities) and the runner system.

**CLAMPING PLATE** - A plate fitted to a mold and used to fasten mold to a molding machine.

**CLARITY** - Material clearness or lack of haze.

**CLOSURE** - A device used to seal off the opening of the bottle, so as to prevent loss of its contents.

**COEFFICIENT OF EXPANSION** - The fractional change in a specified dimension (sometimes volume) of a material for a unit change in temperature. Values for plastics range from 0.01 to 0.2 mils/ in.°C. (ASTM D 696).

**COINJECTION** - Two or more plastic materials may be injected simultaneously or sequentially in a specially designed injection molding machine.

**COLD FLOW** - See **CREEP**.

**COLD MOLDING** - A procedure in which a composition is shaped at room temperature and cured by subsequent baking.

**COLD SHOT** - Incomplete parts which are formed while cycling a molding machine during heat up.

**COLD SLUG** - The first material to enter an injection mold; so called because in passing through sprue orifice it is cooled below the effective molding temperature.

**COLD SLUG WELL** - Space provided directly opposite the sprue opening in an injection mold to trap the cold slug.

**COLOR CONCENTRATE** - A mixture of a measured amount of dye or pigment and a specific plastic material base. A more precise color can be obtained using concentrates rather than using raw colors. Note: Care should be taken to verify that the color concentrate base is compatible with the plastic it is to be used to color. Color concentrate is normally used at 1-4% of the plastic material to be colored.

**COMBINATION MOLD** - See FAMILY MOLD.

**COMPOUND** - A mixture of polymer(s) with all materials necessary for the finished product.

**COMPRESSION MOLD** - A mold which is open when the material is introduced and which shapes the material by heat and by the pressure of closing: used in compression molding.

**COMPRESSION MOLDING** - A technique of thermoset molding in which the molding compound (generally preheated) is placed in the heated open mold cavity, mold is closed, under pressure (usually in an hydraulic press) causing the material to flow and completely fill the cavity, pressure being held until the material has cured.

**COMPRESSION RATIO** - In an extruder or injection/blow molder screw, the ratio of volume available in the first flight at the hopper to the last flight at the end of the screw.

**COMPRESSIVE STRENGTH** - Crushing load at the failure of a specimen divided by the original sectional area of the specimen. (ASTM D 695).

**CONCENTRICITY** - (1) The relationship of all circular surfaces to other circular surfaces with the same center. (2) Relationship of all inside dimensions to all outside dimension, usually as with diameter, expressed in thousandths of an inch F.I.M. (FULL INDICATOR MOVEMENT). Deviation from CONCENTRICITY is many times referred to as "RUNOUT."

**CONDITIONING** - The subjection of a material to a stipulated treatment so that it will respond in a uniform way to subsequent testing or processing. The term is frequently used to refer to the treatment given to specimens before testing. ASTM standard conditions for a plastic testing laboratory are 23°C + 2°C (73.4°F + 3.6°F) and 50% + 5% relative humidity.

**CONVERGENT DIE** - A die in which the internal channels leading to the orifice come together at one point.

**COOLING CHANNELS** - Channels or passageways located within the body of a mold through which a cooling medium can be circulated to control temperature on the mold surface. May also be used for heating a mold by circulating steam, hot oil or other heated fluid through channels as in molding of the thermosetting and some thermoplastic materials.

**COOLING FIXTURE** - Block of metal or wood holding the shape of a molded piece which is used to maintain the proper shape or dimensional accuracy of a molding after it is removed from the mold until it is cooled enough to retain its shape without further appreciable distortion. Also called: SHRINK FIXTURE.

**COPOLYMER** - A polymer produced by polymerization of two or more monomers.

**CORE** - (1) Male element in die which produced a hole or recess in a part. (2) Part of a complex mold that molds undercut parts. Cores are usually withdrawn to one side before the main sections of the mold open. (3) A channel in a mold for circulation of a heat-transfer medium. (4) The central member of a laminate.

**CORE PIN** - Pin used to mold a hole.

**CORE PIN PLATE** - Plate holding core pins.

**CORE ROD** - A rod used to form the internal configuration of an injection blow molded parison or preform.



**CORING** - ( 1 ) (molded part design) - The removal of excess material from the cross section of a molded part to attain a more uniform wall thickness. (2) The method of sizing and shaping a bottle opening by appropriate tools.

**CORONA TREATMENT** - Exposing a plastic part to corona discharge to increase receptivity to inks, lacquers, paints, adhesives, etc. A type of **SURFACE TREATING**.

**COUPLING AGENT** - Treatment of glass fibers to ensure proper bonding between glass fiber and plastic material.

**CRAZING** - Fine cracks which may extend in a network on or under the surface or through a layer of plastic material.

**CREEP** - The dimensional change with time of a material under load, following the initial instantaneous elastic deformation. Creep at room temperature is sometimes called **COLD FLOW**. (ASTM D 674).

**CRYSTALLINITY** - A state of molecular structure in some resins which denotes uniformity and compactness of the molecular chains forming the polymer. Normally can be attributed to the formation of solid crystals having a definite geometric form. Higher crystallinity usually causes a polymer to be less transparent.

**CULL** - Material remaining in a transfer chamber after mold has been filled. Unless there is a slight excess in the charge, the operator cannot be sure cavity is filled.

**CURE** - To change the physical properties of a material by chemical reaction, which may be condensation, polymerization, or vulcanization; usually accomplished by the action of heat and catalysts, alone or in combination, with or without pressure.

**CURING TEMPERATURE** - Temperature at which a cast, molded, or extruded product a resin-impregnated reinforcing material, an adhesive, etc., is subjected to curing.

**CURING TIME** - ( 1 ) In the molding of thermosetting plastics, the interval of time between the instant of cessation of relative movement between the moving parts of a mold and the instant that pressure is released. (2) The time between when the injection pressure stops and the mold opens.

**CUT-OFF** - In compression molding, the line where the two halves of a mold come together. Also called **FLASH GROOVE**, **PINCH-OFF** and **SHUT-OFF** in other operations.

**CYCLE** - The complete, repeating sequence of operations in a process or part of a process. In molding, the cycle time is the period, or elapsed time, between a certain point in one cycle and the same point in the next.

## d

**DAYLIGHT OPENING** - Clearance between two platens of a press in the open position.

**DEBOSS(ED)** - An indent or cut in design (depressed design) or lettering of a surface.

**DEFLASHING** - Covers the range of finishing techniques used to remove the flash (excess, unwanted material) on a plastic molding, such as filing, sanding, milling, tumbling, wheelabrating, etc.

**DEGASSING** - See **BREATHING**.

**DEGRADATION** - A deleterious change in the chemical structure physical properties and/or appearance of a plastic, usually caused by exposure to heat.

**DELAMINATION** - The splitting of a plastic material along the plane of its layers. Physical separation or loss of bond between laminate plies.

**DELIQUESCENT/DELIQUESCENCE** - Attraction of moisture from the air, until the material becomes a saturated liquid.

**DENSITY** - Weight per unit volume of a substance, expressed in grams per cubic centimeter, or pounds per cubic foot.

**DESICCANT** - Substance which can be used for drying purposes because of its affinity for water.

**DESTATICIZATION** - Treating plastics materials to minimize their accumulation of static electricity, and subsequently, the amount of dust picked up by the plastics because of such charges. See **ANTISTATIC AGENTS**.

**DETERIORATION** - A permanent change in the physical properties of a plastic evidenced by impairment of these properties.

**DIAPHRAGM GATE** - Gate used in molding annular or tubular articles. Gate forms a solid web across the opening of the part.

**DIE** - An exactly shaped metal block or device used to shape metal, plastics or other materials.

**DIE GAP** - In blow molding, the distance between the mandrel and die in the blowing head. This clearance governs the thickness of the extruded parison and thus the thickness of the walls of the finished part.

**DIE SWELL RATIO** - The ratio of the outer parison diameter (or parison thickness) to the outer diameter (or die gap).

**DIELECTRIC CONSTANT** - Normally the relative dielectric constant; for practical purposes, the ratio of the capacitance of an assembly of two electrodes separated solely by a plastics insulating material to its capacitance when the electrodes are separated by air. A relative measure of non-conductance.

**DIELECTRIC HEATING** - (Electronics heating or R.F. heating) The plastic to be heated forms the dielectric of a condenser to which is applied a high frequency (20 to 80 mc.) voltage. Dielectric loss in the material is the basis. Process used for sealing vinyl films and preheating thermoset molding compounds.

**DIELECTRIC STRENGTH** - The electric voltage gradient at which an insulating material is broken down or "agreed through," in volts per mil of thickness.

**DIMENSIONAL STABILITY** - Ability of a plastic part to retain the precise shape in which it was molded, fabricated or cast.

### DIMENSIONS (BLOW MOLDING)

**"E" Dimension** - On a threaded bottle neck (finish), the measurement across the root of the threads.

**"H" Dimension** - (1) On a threaded bottle neck (finish), the measurement from the top of the finish to the point where diameter "I" extended parallel to the centerline intersects the shoulder of bead. (2) The inside height of the closure, measured from the bottom of the closure in a line tangent to the threads of the closure and terminating at the inside top of the closure.

**"I" Dimension** - A specified minimum dimension inside the bottle neck that will allow sufficient clearance for filler tubes to enter the bottle neck.

**"L" Dimension** - Measured from the top of the finish to the point where diameter "E" extended parallel to centerline intersects the bead.

**"S" Dimension** - Locates the position of the bottle thread with respect to the top of the finish. It is a vertical distance from the top of the finish to the intersection of the finish wall and the top of the first part of the bottle where full depth contour exists.

**"T" Dimension** - The outside diameter of the thread helix on a bottle finish.

**"W" Dimension** - The width (vertical height) of the neck band on certain bottle finishes.

**DISC GATE** - See **DIAPHRAGM GATE**.

**DISCOLORATION** - Any change from the original color, often caused by overheating, light exposure, irradiation, or chemical attack.

**DISHED** - Showing a symmetrical distortion of a flat or curved section of a plastic object, so that as normally viewed, it appears concave, or more concave than intended.

**DISPERSION** - Finely divided particles of material in suspension in another substance.

**DIVERGENT DIE** - A die in which the internal channels leading to the orifice go in different directions from a common point of each other. (Applicable only to dies for hollow bodies, such as **BLOW MOLDING**).

**DOMED** - Showing a symmetrical distortion of a flat or curved section of a plastic object, so that, as normally viewed, it appears convex, or more convex than intended. See **WARP**.

**DOWEL** - Pin used to maintain alignment between two or more parts of a mold.

**DRAFT** - The degree of taper of a side wall or the angle of clearance designed to facilitate removal of parts from a mold.

**DRY COLORING** - Method commonly used by fabricators for coloring plastic by tumble blending uncolored particles of the plastic material with selected dyes and pigments.

**DUCTILITY** - The extent to which a solid material can be drawn into a thinner cross section without breaking.

**DUPLICATE CAVITY PLATE** - Removable plate that retains cavities, used where two-plate operation is necessary for loading inserts, etc.

**DUROMETER HARDNESS** - The hardness of a material as measured by the Shore Durometer: Indentation Hardness.

**DWELL**- (1) A pause in the application of pressure to a mold, made just before the mold is completely closed, to allow the escape of gas from the thermoset molding material. (2) The time between when the injection ram is fully forward holding pressure on the material within the mold until the time the ram retracts.

**DYES** - An intensely colored synthetic or natural organic chemical which is soluble in most common solvents and dissolves in the plastic substrate while imparting color. Characterized by good transparency, high tinctorial strength, and low specific gravity.

## e

**EJECTION** - The removal of the finished part from the mold cavity by mechanical means.

**EJECTOR PIN** - Or **EJECTOR SLEEVE** - A rod, pin or sleeve which pushes a molding off of a force or out of a cavity of a mold. It is attached to an ejector bar or plate which can be actuated by the ejector rod(s) or the press or by auxiliary hydraulic or air cylinders.

**EJECTOR PIN RETAINER PLATE** - Retainer plate into which ejector pins are assembled.

**EJECTOR RETURN PINS** - Projections that push the ejector assembly back as the mold closes; also called Safety Pin, and Position Pushbacks.

**EJECTOR ROD OR BAR** - A bar that actuates the ejector assembly when mold is opened.

**ELASTIC DEFORMATION** - The part of the deformation of an object under load which is recoverable when the load is removed.

**ELASTICITY** - That property of a material by virtue of which it tends to recover its original size and shape after deformation. If the strain is proportional to the applied stress, the material is said to exhibit Hookean or ideal elasticity.

**ELASTOMER** - A material which at room temperature can be stretched repeatedly under low stress to at least twice its length and snaps back to the original length upon release of stress. See **RUBBER**.

**ELECTRIC DISCHARGE MACHINING (EDM)** - A metal working process applicable to mold construction in which controlled sparking is used to erode away the work piece.

**ELECTROFORMED MOLDS** - A mold made by electroplating metal on the reverse pattern on the cavity. Molten steel may be then sprayed on the back of the mold to increase its strength.

**ELECTROPLATING** - Deposition of metals on certain plastics and mold for finish.

**ELONGATION** - The fractional increase in length of a material stressed in tension, before rupture.

**EMBOSSING** - Techniques used to create depressions of a specific pattern in plastics film and sheeting. Such embossing is in the form of surface patterns on molded part by the treatment of the mold surface by photoengraving or other process.

**ENDOTHERMIC** - Pertaining to an action or reaction which absorbs heat.

**ENVIRONMENTAL STRESS CRACKING (ESC)** - The susceptibility of a thermoplastic article to crack or craze formation under the influence of certain chemicals or aging, or weather, and stress. Standard ASTM test methods that include requirements for environmental stress cracking are indexed in Index of ASTM Standards.

**ETCH** - To treat a mold with an acid, leaving parts of the mold which remain in relief to form the desired design on the bottle.

**EUTECTIC** - Pertaining to a specific mixture of two or more materials which has a lower melting point than any of the constituents or any other mixture of these constituents.

**EXOTHERM** - (1) The temperature/time curve of a chemical reaction giving off heat, particularly the polymerization of casting resins. (2) The amount of heat given off in an exothermic action or reaction. The term has not been standardized with respect to sample size, ambient temperature, degree of mixing, etc.

**EXOTHERMIC** - Pertaining to an action or reaction which gives off heat.

**EXTRUSION** - The plasticizing of a material in an **EXTRUDER** (barrel and screw or plunger assembly) and forcing of the molten material or **EXTRUDATE** through a die or into a mold. The initial part of the molding process.

**EXTRUSION BLOW MOLDING** - A type of blow molding where the parison is formed in open air by an extrusion process.

**EXTRUSION PLASTOMER** - An instrument used to determine **MELT FLOW INDEX (MFI)**.

## f

**FABRICATE** - To work a material into a finished form by machining, forming, or other operation. In the broadest sense it means to manufacture.

**FAMILY MOLD** - (1) A multi-cavity mold wherein each of the cavities form as a part which has a direct relationship in usage to the other parts in the mold. Family molds can have more than one cavity making the same part but they will still always have that same direct relationship to usage. (2) A multi-cavity mold wherein each of the cavities forms one of the component parts of the assembled finished object. The term often applied to molds wherein parts from different customers are grouped together in one mold for economy of production. Sometimes called **COMBINATION MOLD**.

**FAN GATE** - A shallow gate somewhat wider than the runner from which it extends.

**FIBER (FIBRE)** - This term usually refers to thin fibers of glass which are used to reinforce both thermoplastic and thermosetting materials. One inch long fibers are occasionally used, but the more commonly used fiber lengths are 1/2" and 1/4", or less.

**FILL-AND-WIPE** - Parts are molded with depressed designs, after application of paint, surplus paint is wiped off, leaving paint remaining only in depressed areas. Sometimes called **WIPE-IN**.

**FILLER** - An inert substance added to plastics for the purpose of improving physical properties or processability, or to reduce cost of the material.

**FILLET** - A rounded filling of the internal angle between two surfaces.

**FINES** - Very small particles mixed in with larger particles.

**FINISH** - (1) To complete the secondary work on a molded part so that it is ready for use. Operations such as filing, deflashing, buffing, drilling, tapping, degating are commonly called finishing operations. (2) **SURFACE FINISH**. (3) The plastic forming the opening of a bottle shaped to accommodate a specific closure. (4) The ultimate surface structure of a part.

**FIXTURE** - Means of holding a part during a machine or other operation.

**FLAME TREATMENT** - A type of **SURFACE TREATMENT** which oxidizes a plastic surface for better reception of paint, inks, and adhesives.

**FLAMMABILITY** - Measure of the extent to which a material will support combustion.

**FLASH** - Extra plastic attached to a molding along the parting line; under most conditions it would be objectionable and must be removed before the parts are acceptable.

**FLASH GATE** - Usually a long gate extending from a runner which runs parallel to an edge of a molded part along the flash or parting line of the mold.

**FLASH GROOVE** - See **CUT-OFF**.

**FLASH LINE** - A raised line appearing on the surface of a molding and formed at the junction of mold faces. See **PARTING LINE**.

**FLASH MOLD** - A mold in which the mold faces are perpendicular to the clamping action of the press, so that the higher the clamping force, the tighter the mold seam.

**FLEXIBLE MOLDS** - Molds made of rubber or elastomeric plastics used for casting plastics. They can be stretched to remove cured pieces with undercuts.

**FLEXURAL STRENGTH** - Ability of a material to flex without permanent distortion or breaking (ASTM D 790).

**FLOW** - (1) a qualitative description of the fluidity of a plastic material during the process of molding. (2) a quantitative value of fluidity when expressing a **MELT FLOW INDEX**.

**FLOW LINE** - A mark on a molded piece made by the meeting of two flow fronts during molding. Also called **WELD LINE** or **WELD MARK**.

**FLOW MARKS** - Wavy surface appearance on a molded object caused by improper flow of the material into the mold. See **SPLAY MARKS**.

**FOAMED PLASTICS** - Resins in sponge form. The sponge may be flexible or rigid, the cells closed or interconnected, the density anything from that of the solid parent resin down to, in some cases 2 lb./ cu. foot. (**CELLULAR PLASTICS**)

**FOIL DECORATING** - Molding paper, textile, or plastic foils printed with compatible inks directly into a plastic pan so that the foil is visible below the surface of the part as integral decoration.

**FORCE** - (1) (**PHYSICS**) That which changes the state of rest or motion in matter, measured by the rate of change of **MOMENTUM**. (**NEWTON**) (2) That portion of the mold which forms the inside of the molded part. Sometimes called a **CORE** or a **PLUNGER**.

**FORCE PLATE** - The plate that carries the plunger or force plug of a mold and guide pins or bushings.

FRICITION WELDING - See SPIN WELDING.

FULL INDICATOR MOVEMENT (F.I.M.) - A term in current use to identify tolerance with respect to CONCENTRICITY. "Former Practices" terms are FULL INDICATOR READING (F.I.R.) or (T.I.R.) TOTAL INDICATOR READING "RUNOUT."

### g

GARDNER - A type of drop weight IMPACT testing.

GAS ASSISTED INJECTION MOLDING (GAM) - An injection molding process which utilizes a special adaptation of introducing a gas (usually nitrogen) into the plasticized material, to form voids in strategic locations.

GATE - In injection and transfer molding, the orifice through which the melt enters the cavity.

GLASS TRANSITION POINT - The temperature range when a reversible change occurs in a polymer, indicated by the change from a viscous or rubbery state to a hard, brittle state.

GLOSS - The shine or luster of the surface of a material. See SURFACE FINISH and SPECULAR GLOSS. (ASTM D 673)

GRIT BLASTED - A surface treatment of a mold in which steel grit or sand materials are blown to the walls of the cavity to produce a roughened surface. Air escape from mold is improved and special appearance of molded article is often obtained by this method.

GPC- GEL PERMEATION CHROMATOGRAPH - Used to determine MOLECULAR WEIGHT DISTRIBUTION.

GUIDE PINS - Devices that maintain proper alignment of force plug and cavity as mold closes. Also called LEADER PINS.

GUSSET - A piece used to give strength or additional size in a particular location of an object.

### h

HARDNESS - The resistance of a material to compression and indentation. Among the most important methods of testing this property are Brinell hardness, Rockwell hardness and Shore hardness.

HAZE - The degree of cloudiness in a plastics material.

HEAD - The end section of the molding machine that consists of the core, die, mandrel, mold or other parts necessary to form the plastic into a part.

HEAT STABILITY - The resistance of a plastic material to chemical deterioration during processing.

HEAT-DISTORTION POINT (HEAT DEFLECTION TEMPERATURE) - The temperature at which a standard test bar deflects 0.010 in. under a stated load of either 66 or 264 psi. (ASTM D 648).

HEATING CHAMBER - In injection molding, that part of the machine in which the cold feed is reduced to a hot melt. Also called HEATING CYLINDER.

HOB - A master model in hardened steel used to sink the shape of a mold cavity into a soft steel block.

HOBBING - Forming multiple mold cavities by forcing a hob (q.v.) into soft steel cavity blanks. Also called SINKING.

HOMOPOLYMER - A polymer which is the product of the polymerization of a single monomer (repeating unit).

HOPPER - A conical reservoir from which the molding powder or pellets feed into the extruder screw.

HOT/HEATED MANIFOLD MOLD - A thermoplastic injection mold in which the portion of the mold which contains the runner system has its own heating elements which keep the molding material in a plastic state ready for injection into the cavities, from which the manifold is insulated.

**HOT RUNNER MOLD** - A thermoplastic injection mold in which the runners are insulated from the chilled cavities and remain hot so that the center of the runner never cools in normal cycle operation. Runners are not usually ejected with the molded pieces. Called **INSULATED RUNNER MOLDS** when heating elements are not used in mold. Note: A **HEATED MANIFOLD MOLD** is a **HOT RUNNER MOLD** which is both heated and insulated and an **INSULATED MOLD** is a **HOT RUNNER MOLD** which does not contain heaters.

**HOT-STAMPING** - Engraving operation for marking plastics in which roll leaf is dyed or (metalized foil) stamped with heated metal dies onto the face of the plastics. Also called **BRANDING**.

**HYDROLYSIS** - Chemical decomposition of a material involving the addition of water.

**HYGROSCOPIC** - Tending to absorb moisture from air.

### i

**IMPACT STRENGTH** - (1) The ability of a material to withstand shock loading. (2) The work done in fracturing, under shock loading, a specified test specimen in a specified manner. (3) The relative susceptibility of plastic articles to fracture under stress applied at high speeds: **PENDULUM IMPACT (IZOD & CHARPY)**; **DROP WEIGHT TEST (GARDNER & DART)**; **TENSILE IMPACT**.

**INJECTION BLOW MOLDING** - A blow molding process in which the parison to be blown is formed in a mold, similar to injection molding.

**INJECTION MOLDING** - A molding procedure whereby a heat-softened plastic material is fed into a cavity (mold) which gives the article the desired shape using a screw or ram. Used with both thermoplastic and thermosetting materials.

**INJECTION PRESSURE** - The pressure in the mold during the injection of plasticized material into the mold cavity. Expressed in p.s.i., with the hydraulic system pressure being used to indicate changes, when there are not sensors in the mold.

**INJECTION RAM** - See **RAM**

**INSERT** - An integral part of a plastics molding, consisting of metal or other material, which may be molded into position or may be pressed into the molding after the molding is completed. Also a removable or interchangeable component of the mold.

**INSTRON** - One of the common manufacturers of **UNIVERSAL TESTING MACHINES**.

**IZOD** - A type of pendulum **IMPACT**.

### j

**JETTING** - Turbulent flow of plastic from an undersized gate or thin section into a thicker mold section, as opposed to laminar flow of material progressing radially from a gate to the extremities of the cavity. May also result from shooting material into a mold cavity where there is no core or immediate cavity wall to break up the flow of the material coming through the gate.

**JIG** - A device for holding parts and guiding the tool during machine or assembly operation.

### k

**KIRKSITE** - An alloy of aluminum and zinc used for the construction of prototype molds; it imparts a high degree of heat conductivity to the mold.

**KNIT LINES** - See **FLOW LINE**.

**KNOCKOUT PIN** - See **EJECTOR PIN**.

### I

**LAMINAR FLOW** - Laminar flow of thermoplastic resins in a mold is accompanied by solidification of the layer in contact with the mold surface that acts as an insulating tube through which material flows to fill the remainder of the cavity. This type of flow is essential to duplication of the mold surface.

**LAND** - (1) The horizontal bearing surface of a semi-positive or flash mold by which excess material escapes. See **CUT-OFF**. (2) The bearing surface along the top of the flights of a screw in a screw extruder; (3) the surface of an extrusion die parallel to the direction of melt flow. (4) The bearing surfaces of any mold. (5) The gate when entering a part has either one or two dimensions depending upon their shape. There is always one more dimension involved that is the length of the gate itself. This would be called the **LAND**. On a round gate, it is the second dimension. On a rectangular or square gate, it is the third dimension.

**LIGHT-RESISTANCE** - The ability of a plastics material to resist fading after exposure to sunlight or ultraviolet light. (ASTM D 1501) **LIGHT STABILITY** is the measure of this resistance.

**LOADING TRAY** - A device in the form of a specially designed tray which is used to load the charge of material or metal inserts simultaneously into each cavity of a multi-cavity mold by the withdrawal of a sliding bottom from the tray. Also called **CHARGING TRAY**.

**LOSS FACTOR (electrical)** - The product of the power factor and the dielectric constant of a dielectric material.

### m

**MACERATE** - (v.) To chop or shred fabric for use as a filler for a molding resin. - (n.) The molding compound obtained when so filled.

**MACROMOLECULE** - The large (grant) molecules which make up high polymers.

**MANDREL** - The inner portion of the extrusion blow molder die head which is used to adjust parison wall thickness. Also called **DIE PIN**.

**MANIFOLD** - A pipe channel, or mold with several inlets or outlets.

**MATCHED METAL (DIE) MOLDING** - Method of molding reinforced plastics between two close fitting metal molds mounted in a press.

**MATERIAL WELL** - Space provided in a compression mold to care for bulk factor of the material load.

**MATTE FINISH** - A type of dull, non-reflective finish. See **SURFACE FINISH**.

**MELT INDEX (MI) or MELT FLOW INDEX (MFI)** - The amount, in grams, of a thermoplastic resin which can be forced through a 0.0825 inch orifice when subjected to the prescribed force (grams) in 10 minutes at the prescribed temperature, (°C) using an Extrusion Plastometer. (ASTM D 1238).

**MELT STRENGTH** - The strength of the plastic while in the molten state.

**MER** - Polymer repeating unit.

**METER** - SI length unit equal to 100 centimeters or 39.37 inches.

**METERING SCREW** - An extrusion or injection molder screw which has a shallow constant depth, and constant pitch section, usually over the last 3 to 4 flights.

**MICA** - Any of a group of mineral silicates crystallizing in monoclinic forms that readily separate into very thin leaves. Used as a filler for plastics molding materials.

**MIGRATION OF PLASTICIZER** - Loss of plasticizer from an elastomeric plastic compound with subsequent absorption by an adjacent medium or lower plasticizer concentration.



**MIL** - English Unit of length equal to 0.001 inch or 0.00254 centimeters.

**MODULUS OF ELASTICITY** - The ratio of stress to strain in a material that is elastically deformed. (Below the proportional limit: **YOUNG'S MODULUS**), (ASTM D 790).

**MOISTURE - (1) ABSORPTION** - The pickup of moisture from the atmosphere by a material which penetrates the interior; **(2) ADSORPTION** - Surface retention of moisture from the atmosphere.

**MOISTURE VAPOR TRANSMISSION RATE (MVTR)** - The rate at which water vapor permeates through a plastic film or wall at a specified temperature and relative humidity. (ASTM E 96).

**MOLD** - (n.) A medium or tool designed to form desired shapes and sizes. - (v.) To process a plastics material using a mold.

**MOLD RELEASE** - (1) A lubricant used to coat a mold cavity to prevent the molded piece from sticking to it, and thus to facilitate its removal from the mold. (2) Additives put into material to serve as a mold release. Also called **RELEASE AGENT**.

**MOLDING** - Used to describe a group of plastics processes using molds.

**MOLDING CYCLE** - The period of time required to complete a cycle and produce a part/product.

**MOLDING MATERIAL** - Plastics material in varying stages of granulation often comprising plastic or resin, filler, pigments, plasticizers and other ingredients, ready for use in the molding operation. Also called **MOLDING COMPOUND** or **POWDER**.

**MOLDING PRESSURE** - (1) The pressure applied directly or indirectly on the compound to allow the complete transformation to a solid dense part. (2) The pressure developed by a ram or screw to push molten plastic into a mold cavity. See **INJECTION PRESSURE**.

**MOLDING SHRINKAGE** - The difference in dimensions, expressed in inches per inch, between a molding and the mold cavity in which it was molded, both the mold and molding being at normal room temperature when measured. Also called **MOLD SHRINKAGE**, and **CONTRACTION**.

**MOLECULAR WEIGHT (MW) (Average Molecular Weight)** - The sum of the atomic masses of the elements forming the molecule, indicating the relative size typical chain length of the polymer molecule.

**MOLECULAR WEIGHT DISTRIBUTION (MWD)** - Normally determined using a Gel Permeation Chromatograph (GPC), MWD is the plot of a fraction of a MW sphere versus the molecular weight.

**MONOMER** - A low molecular weight reactive chemical which polymerizes to form a polymer.

**MORPHOLOGY** - The study of the physical form and structure of a material.

**MOVABLE PLATEN** - The moving platen of an injection or compression molding machine to which half of the mold is secured during operation. This platen is moved either by a hydraulic ram or a toggle mechanism.

**MULTI-CAVITY MOLD** - A mold having more than one cavity or impression for forming finished items at one machine cycle.

## n

**NECKING** - The localized reduction of cross-sectional area of an object.

**NEWTON** - The SI Unit of force equal to approximately 0.111 tons.

**NOTCH SENSITIVITY** - A measure of the reduction in load-carrying ability caused by a stress concentration in a test specimen (**IMPACT TESTING - IZOD and CHARPY**).

**NOZZLE** - The hollow cored metal nose screwed into the extrusion end of (a) the heating cylinder of an injection machine, or (b) a transfer chamber where this is a separate structure.



**OLEFINS** - A group of unsaturated hydrocarbons of the general formula  $C_nH_{2n}$ , and named after the corresponding paraffins by the addition of "ene" or "ylene" to the stem. Examples are ethylene and propylene. The polymer products are **POLYOLEFINS**.

**OLEFIN PLASTICS** - Plastics produced from olefins (**POLYOLEFINS**). Examples are polyethylene and polypropylene.

**OPAQUE** - A material which will not transmit light and cannot be seen through.

**ORANGE PEEL** - A type of granular surface finish resembling the peel of an orange.

**ORIENTATION** - The alignment of the crystalline structure in polymeric materials so as to produce a highly uniform structure. Can be accomplished by cold drawing or stretching during fabrication.

**ORIFICE** - An opening in a die or other metal piece used to meter (control the flow of) fluid material.

**OUT-OF-ROUND** - Non-uniform radius or diameter.

**OVERLAY SHEET** - See **FOIL DECORATING**. Also called **SURFACING MAT**.

**OXIDATION** - (1) Degradation of a material through contact with air. (2) A chemical reaction involving combination with oxygen to form new compounds.

**OXYGEN INDEX** - An indication of flammability.

## P

**PARALLELS** - The support spacers placed between the mold and press platen or clamping plate. Also called **RISERS** or **SUPPORT FILLERS**.

**PARISON** - The hollow tube of thermoplastic material which is pinched at one or both ends and inflated in a mold to make a hollow part, i.e. Blow Molding.

**PARTING AGENT** - See **MOLD RELEASE**.

**PARTING LINE** - (1) The points in the mold where two or more metal surfaces meet creating a shut off. (2) Mark on a molding or casting where halves of mold met in closing.

**PARTITIONED MOLD COOLING** - See **BUBBLER**.

**PERMEABILITY** - (1) The passage or diffusion of a gas, vapor, liquid or solid through a material without chemically or physically affecting it. (2) The rate of the passage in (1).

**PIGMENT** - Imparts color to plastic while remaining a dispersion of undissolved particle.

**PILL** - See **PREFORM**.

**PINCH-OFF** - See **CUT-OFF**.

**PINPOINT GATE** - A restricted orifice through which molten plastic flows into a mold cavity. Also called **RESTRICTED GATE**.

**PITCH** - (One example) With respect to extruder or injection molding, the distance from any point on the flight of a screw line to the corresponding point on an adjacent flight, measured parallel to the axis of the screw line or threading.

**PLASTIC** - (n) One of the high polymeric materials, either natural or synthetic, exclusive of rubbers, which either melt and flow with heat and pressure, as with a thermoplastic or chemically "set" as with a thermoset material. (v) Capable of flow under pressure or tensile stress: **MADE OF PLASTICS**.

**PLASTIC DEFORMATION** - The deformation of a material under load that is not recoverable after the load is removed: As opposed to **ELASTIC DEFORMATION**.

**PLASTIC MEMORY** - A phenomenon of plastics to return, in some degree, to its original form upon heating.

**PLASTICATE** - To soften by heating or kneading. Synonyms are: plastify, flux, and (imprecisely) plasticize (q.v.).

**PLASTICITY** - A property of plastics which allows the material to be deformed continuously and permanently without rupture upon the application of a force that exceeds the yield value of the material.

**PLASTICIZE** - To make a material soft and moldable with the addition of heat and/or pressure or a plasticizer.

**PLASTICIZER** - Chemical added to a plastic to make it soften and more flexible.

**PLASTISOLS** - Mixtures of vinyl resins and plasticizers which can be molded, cast, or converted to continuous films by the application of heat. If the mixtures contain volatile thinners also, they are known as **ORGANOSOLS**.

**PLATE DISPERSION PLUG** - See **BREAKER PLATE**.

**PLATENS** - The mounting plates of a press to which the entire mold assembly is bolted.

**PLUNGER** - The part of a transfer or injection press that applies pressure on the unmelted plastic material to push it into the chamber, which in turn forces plastic melt at the front of the chamber out through the nozzle. See **RAM**.

**POLYLINER** - (1) A perforated longitudinally ribbed sleeve that fits inside the cylinder of an injection molding machine; used as a replacement for conventional injection cylinder torpedoes (older machines). (2) A plastic bag placed inside a carton or box to prevent material contamination during shipment.

**POLYMER** - A high-molecular-weight organic compound, natural or synthetic, whose structure can be represented by a repeated small unit, the **MER**; e.g., polyethylene, rubber, cellulose. Synthetic polymers are formed by addition or condensation polymerization of monomers. If two or more monomers are involved, a copolymer is obtained. Some polymers are elastomers, some plastics.

**POLYMERIZATION** - A chemical reaction in which the molecules of a monomer are linked together to form large molecules whose molecular weight is a multiple of that of the original substance. When two or more monomers are involved, the process is called copolymerization. Addition and condensation are the two major types of reactions.

**POLYOLEFINS** - See **OLEFIN PLASTICS**.

**POSITIVE MOLD** - A compression mold designed with vertical shut-off.

**POSTFORMING** - A process used to impart a shape to a previously molded article.

**POWDER MOLDING** - Techniques for producing objects of varying sizes and shapes by melting thermoplastic powder against the inside of a mold. In compression molding, a method of charging the mold with loose powder.

**PREFORM** - A pill, tablet, or biscuit used in thermoset molding. Material measured by volume, the bulk factor of powder reduced by pressure all in the interest of efficiency and accuracy.

**PREHEATING** - The heating of a compound prior to molding or casting in order to facilitate the operation, reduce cycle, and improve product.

**PREMIX** - A molding compound prepared prior to and apart from the molding operations and containing all components required for molding; resin, reinforcement fillers, catalysts, release agents, and other compounds.

**PREPLASTICATION** - Technique of premelting injection molding powders in a separate chamber, then transferring the melt to the injection cylinder. Device used for preplastication is commonly known as a preplasticizer.

**PREPREG** - A term generally used in reinforced plastics to mean the reinforcing material containing or combined with the full complement of resin before molding.

**PRESSURE PADS** - Reinforcements distributed around the dead areas in the faces of a mold to help the land absorb the final pressure of closing without collapsing.

**PROGRAMMING** - (1) A system of altering the die gap opening while the parison is being extruded so that the wall thickness of the extruded parison may be varied to control the wall thickness or resin distribution in the finished blow molded article. (2) preparation of a computer for operations.

**PROTOTYPE MOLD** - A simplified mold construction often made from a light metal casting alloy or from an epoxy resin in order to obtain information for the final mold and/or part design.

**PURGING** - Cleaning one color or type of material from the cylinder of an injection molding machine or extruder by forcing it out with the new color or material to be used in subsequent production. Purging materials are also available.

## R

**RADIO FREQUENCY (R.F.) PREHEATING** - A method of preheating used for molding materials to facilitate the molding operation and/or reduce the molding cycle. The frequencies most commonly used are between 10 and 100 mc/sec.

**RAM** - The press member that enters the cavity block and exerts pressure on the molding compound designated as the "top force" or "bottom force" by position in the assembly. See **PLUNGER**.

**RAM TRAVEL** - Distance ram moves when operating a complete molding cycle.

**RECIPROCATING SCREW** - A combination injection and plasticizing unit in which an extrusion device with a reciprocating screw is used to plasticize the material. Injection of material into a mold can take place by direct extrusion into the mold, or by reciprocating the screw as an injection plunger, or by a combination of the two. When the screw serves as an injection plunger, this unit acts as a holding, measuring, and injection chamber.

**RECYCLED PLASTICS** - A plastic material prepared from previously used or processed plastic materials which have been cleaned and reground.

**REGRIND** - (1) Waste plastics which are recovered and reprocessed for reuse. (2) Plastics which have been ground or pelletized at least twice.

**REINFORCED MOLDING COMPOUND** - A material reinforced with special fillers to meet specific requirements (rag, glass, etc.).

**RELEASE AGENT** - See **MOLD RELEASE**.

**RELIEF ANGLE** - (1) The angle of the cutaway portion of the pinch-off blade measured from a line parallel to the pinch-off land. (2) In a mold the relief angle is the angle between the narrow pinch-off land and the cutaway portion adjacent to the pinch-off land.

**RESIN** - (1) Any of a class of solid or semi-solid organic products of natural or synthetic origin, generally of high molecular weight with no definite melting point. Most resins are polymers (q.v.). (2) In a broad sense, the term is used to designate any polymer that is a basic material for plastics.

**RESIN POCKET** - An apparent accumulation of excess resin in a small localized section visible on cut edges of molded surfaces. Also called **RESIN SEGREGATION**.

**RETAINER PLATE** - The plate on which demountable pieces, such as mold cavities, ejector pins, guide pins, and bushings are mounted during molding; usually drilled for steam or water.

**RHEOLOGY** - The study of flow.

**RIB** - A reinforcing member of a fabricated or molded part.

**RIM** - Reaction Injection Molding.

**ROCKWELL HARDNESS** - A common method of testing material for resistance to indentation in which a diamond or steel ball, under pressure, is used to pierce the test specimen. (ASTM D 785).

**ROLL MILL** - A two roll mixer that is used to mix plastics with a shearing action.

**ROTATING SPREADER** - A type of injection torpedo which consists of a finned torpedo which is rotated by a shaft extending through the tubular cross section injection ram behind it.

**ROTATIONAL MOLDING or CASTING** - A process used to make hollow plastic parts.

**RUBBER** - An elastomer, either synthetic or natural polymer, which is capable of rapid elastic recovery.

**RUNNER (Refers to mold)** - In an injection or transfer mold, the channel that connects the sprue with the gate to the cavity.

**RUNNER SYSTEM (Refers to plastic)** - The term usually applied to all the material in the form of sprues, runners and gates which lead material from the nozzle of an injection machine to the pot of a transfer mold to the mold cavity.

## S

**SCRAP** - A product or material which is out of specification to point of making it unusable.

**SCREW PLASTICATING INJECTION MOLDING** - See INJECTION MOLDING.

**SEGREGATION** - A separation of components in a molded article usually denoted by wavy lines and color striations in thermoplastics. In thermosettings, usually meaning segregation of resin and filler on surface.

**SEMI-AUTOMATIC MOLDING MACHINE** - A molding machine in which only part of the operation is controlled by the direct action of a human. The automatic part of the operation is controlled by the machine according to a predetermined program.

**SEMIPOSITIVE MOLD** - A mold whose principle is: As the two halves of the mold begin to close, the mold acts much like a flash mold, as the excess material is allowed to escape around the loose fitting plunger and cavity. As the plunger telescopes further into the cavity, the mold becomes a positive mold with very little clearance and full pressure is exerted on the material, producing a part of maximum density. This type of mold takes advantage of the free flow of material in a flash mold and the quality of producing dense parts in the positive mold.

**SHAW POT** - The original thermosetting transfer molding process. A conventional hydraulic press is used, without auxiliary cylinder. The molding material is put in a pot suspended above the mold and when the press is closed the material flows from the pot into the mold cavity (cavities).

**SHEAR** - Stress developed in material due to the action of the layers in the material attempting to glide against or separate in a parallel direction. (SHEAR STRENGTH)

**SHELF LIFE** - An expression to describe the time a thermoset material such as molding compound can be stored without losing any of its original physical or functional properties.

**SHORE HARDNESS** - A method of determining the hardness of a plastic material using a scleroscope. This device consists of a small conical hammer fitted with a diamond point and acting in a glass tube. The hammer is made to strike the material under test and the degree of rebound is noted on a graduated scale. Generally, the harder the material the greater will be the rebound. (ASTM D 2240).

**SHORT OR SHORT SHOT** - A molded part produced when the mold has not been filled completely.

**SHOT** - The yield from one complete molding cycle, including cull, runner, and flash.

**SHOT CAPACITY** - The maximum volume of material which a machine can produce from one forward motion of the plunger or screw.

**SHOULDER** - That part of a bottle between the main body and the neck.

**SHRINKAGE** - In a plastic, normally the reduction in dimensions after cooling.

**SHRINK FIXTURE** - See **COOLING FIXTURE**.

**SHUT-OFF** - See **CUT-OFF**.

**SIDE ACTIONS (SIDE CORING OR SIDE DRAW PINS)** - (1) An action built into a mold which operates at an angle to the normal open and close action of the mold and is used to facilitate the removal of parts which would not clear a cavity or core on the normal press action. (2) Projections used to core a hole in a direction other than the line of closing of a mold, and which must be withdrawn before the part is ejected from the mold.

**SILK SCREEN PRINTING** - This printing method, in its basic form, involves laying a pattern of an insoluble material, in outline, on a finely woven fabric, so that when ink is drawn across is able to pass through the screen only in the desired areas. Also called "Screen Process Decorating."

**SILICONE (SI)** - (1) Chemical derived from silica used in molding as a release agent and general lubricant. (2) A silicon based thermoset plastic material.

**SINK MARK** - A depression or dimple on the surface of an injection molded part due to collapsing of the surface following local internal shrinkage after the gate seals. May also be an incipient short shot.

**SI UNITS - SYSTEMS INTERNATIONAL UNITS.**

**SMC - SHEET MOLDING COMPOUND.**

**SOLVENT** - Any substance, usually a liquid, which dissolves other substances.

**SPECIFIC GRAVITY** - The density (mass per unit volume) of a liquid or solid material divided by that of water. (ASTM D 792).

**SPECULAR GLOSS** - The relative reflective appearance of a material as judged visually.

**SPIDER GATE** - Multi-gating of a part through a system of radial runners from the sprue.

**SPIN WELDING** - A process of fusing two objects together by forcing them together while one of the pair is spinning, until frictional heat melts the interface. Spinning is then stopped and pressure held until they are frozen together.

**SPIRAL FLOW TEST** - A method for determining the flow properties of a thermoplastic or thermoset material in which the resin flows along the path of a spiral cavity. The length of the material which flows into the cavity and its weight gives a relative indication of the flow properties of the resin.

**SPLAY MARKS or SPLAY** - Marks or lines found on the surface of a part after molding which may be caused by overheating the material, moisture in the material, or flow paths in the part. Usually white, silver, or gold in color. Also called **SILVER STREAKING**.

**SPLIT-RING MOLD** - A mold in which a split cavity block is assembled in a chase to permit the forming of undercuts in a molded piece. These parts are ejected from the mold and then separated from the molded piece.

**SPREADER/TORPEDO** - A streamlined metal block placed in the path of flow of the plastics material in the heating cylinder of extruders and injection molding machines to spread it into thin layers, thus forcing it into intimate contact with the heating areas.

**SPRUE** - Feed opening provided in the injection or transfer mold; also, a slug formed at this hole. Spur is a shop term for the sprue slug.

**SPRUE-BUSHING** - A hardened steel insert in an injection mold which contains the tapered sprue hold and has a suitable seat for the nozzle of the injection cylinder. Sometimes called an Adapter.

**SPRUE GATE** - A passageway through which molten plastic flows from the nozzle to the mold cavity.

**SPRUE LOCK OR PULLER** - In injection molding, a portion of the plastic composition which is held in the cold slug well by an undercut; used to pull the sprue out of the bushing as the mold is opened. The sprue lock itself is pushed out of the mold by an ejector pin.

**STABILIZER** - An ingredient used in the formulation of some plastics to assist in maintaining the physical and chemical properties of the compounded materials at their initial values throughout the processing and service life of the material.

**STATIONARY PLATEN** - The plate of an injection or compression molding machine to which the front plate of the mold is secured during operation. This platen does not move during normal operation.

**STEAM PLATE** - Mounting plate for molds, cored for circulation of steam.

**STEREOLITHOGRAPHY** - A three-dimensional printing process which produces copies of solid or surface models in plastic. The process uses a moving laser beam, directed by computer, to print or draw cross sections of the model onto the surface of photo-curable liquid plastic.

**STRAIN** - The dimensionless numbers (or units of length/length, i.e. inch per inch) that characterizes the change of dimensions of a test specimen during controlled deformation. In tensile testing; the elongation divided by the original gage length of the test specimen.

**STRESS** - The force applied to produce, or tend to produce, deformation of a material. The ratio of applied load to the original cross-sectional area of a test specimen (psi).

**STORAGE LIFE** - See SHELF LIFE.

**STRESS CRACK** - External or internal cracks in a plastic caused by tensile stresses less than its short-term mechanical strength.

**STRIATION** - ( 1 ) A separation of colors resulting in a linear effect of color variation. (2) In blow molding, the rippling of thick parisons. (3) A longitudinal line in a plastic due to a disturbance in the melt path.

**STRIPPER-PLATE** - A plate that strips a molded piece from core pins or cores.

**STYRENIC** - Indicates a group of plastics materials which are polymers, either whole or partially polymerized from styrene monomer.

**SUBMARINE GATE** - A type of edge gate where the opening from the runner into the mold is located below the parting line or mold surface as opposed to conventional edge gating where the opening is machined into the surface of the mold. With submarine gates, the item is broken from the runner system on opening of the mold or ejection from the mold.

**SURFACE FINISH** - Finish of molded produce. Refer to SPI-SPE Mold Finishes Comparison Kit, available from DME Corp., Detroit, Mich.

**SURFACETREATING** - Any method of treating a material so as to alter the surface and render it receptive to inks, paints, lacquers, and adhesives such as chemical, flame, and electronic treating.

**SURGING** - Unstable pressure build-up in an extruder leading to variable throughput and waviness of the extruder.

### t

**TAB GATED** - A small removable tab of approximately the same thickness as the mold item, usually located perpendicular to the item. The tab is used as a site for edge gate location, usually on items with large flat areas.

**TAPPING** - Cutting threads in the walls of a circular hole.

**TENSILE STRENGTH** - The pulling stress, in psi, at a given point on the materials stress - strain curve, usually just before the material tears or breaks. Area used in computing strength is usually the *original*, rather than the necked-down area. (ASTM D 638).

**THERMAL CONDUCTIVITY** - Ability of a material to conduct heat.

**THERMAL STRESS CRACKING (TSC)** - Crazing and cracking of some thermoplastic resins which results from over-exposure to elevated temperatures.

**THERMOPLASTIC (TP)** - (a.) Capable of being repeatedly softened by heat and hardened by cooling (n.) A material that will repeatedly soften when heated and harden when cooled. Typical of the thermoplastic family are the styrenic polymers and copolymers, acrylics, cellulose, polyethylene, polypropylene, vinyls, nylons, and the various fluorocarbon materials.

**THERMOSET (TS)** - A material that will undergo or has undergone a chemical reaction by the action of heat and pressure, catalysts, ultra-violet light, etc., leading to a relatively infusible state. Typical of the plastics in the thermosetting family are the aminos (melamine and urea), unsaturated polyesters, alkyds, epoxies, and phenolics. A common thermoset goes through three stages:

**A-STAGE:** An early stage when the material is soluble in certain liquids, fusible, and will flow.

**B-STAGE:** An intermediate stage when the material softens when heated and swells in contact with certain liquids, but does not dissolve or fuse. Molding Compound Resins are in this stage.

**C-STAGE:** The final stage is the TS reaction when the material is insoluble, infusible and cured.

**THREAD PLUG, RING, OR CORE** - A part of a mold that shapes a thread.

**TIE BARS** - Bars which provide structural rigidity to the clamping mechanism of a press and usually guide platen movement.

**T.I.R.** - An abbreviation used to identify tolerances with respect to **CONCENTRICITY**. Total Indicator Reading - standard terminology for drafting and machinist work. NOTE: The term T.I.R. is a "FORMER PRACTICES" term; the more acceptable current term is F.I.M. (Full Indicator Movement).

**TOGGLE or TOGGLEACTION** - A mechanism which exerts pressure developed by the application of force on a knee joint. It is used as a method of closing presses and also serves to apply pressure at the same time.

**TORPEDO** - See **SPREADER**.

**TOLERANCE** - A specified allowance for deviations in weighing, measuring, etc., or for deviations from the standard dimensions or weight. Ref: SPI Guidelines of Plastics Custom Molders.



**TRANSFER MOLDING** - A method of molding thermosetting materials, in which the plastic is first softened by heat and pressure in a transfer chamber, then forced by high pressure through suitable sprues, runners, and gates into a closed mold for final curing a variation of **COMPRESSION MOLDING**.

**TRANSLUCENT** - A material which can transmit light, but cannot be seen through.

**TRANSPARENT** - A material with a high degree of light transmission and can be easily seen through.

**TUMBLING** - (1) Finishing operation for small plastic articles by which gates, flash, and fins are removed and/or surfaces are polished by rotating them in a barrel together with wooden pegs, saw dust, and polishing compounds. (2) Adding color to a material through **TUMBLE BLENDING**.

**TUNNEL GATE** - See **SUBMARINE GATE**.

## u

**ULTIMATE STRENGTH** - Strength (stress in psi) at the break point in tensile test.

**ULTRASONIC SEALING OR BONDING** - A sealing method in which sealing is accomplished through the application of vibratory mechanical pressure at ultrasonic frequencies (20 to 40 kc.). Electrical energy is converted to ultrasonic vibrations through the use of either a magnetostrictive or piezoelectric transducer. The vibratory pressures at the interface in the sealing area develop localized heat losses which melt the plastic surfaces effecting the seal.

**ULTRASONIC INSERTION** - The inserting of a metal insert into a thermoplastic part by the application of vibratory mechanical pressure at ultrasonic frequencies.

**UNDERCUT** - (a.) Having a protuberance or indentation that impedes withdrawal from a mold in its normal open/closed movement. Flexible materials can be ejected intact even with slight undercuts. (n.) Any such protuberance or indentation; depends also on design of mold.

**UNIT MOLD** - (1) Mold designed for quick changing interchangeable cavity parts. (2) A mold which comprises only a single cavity, frequently a pilot for the production set of molds.

**UNIVERSAL TESTING MACHINE** - A testing machine used to determine tensile, flexural, or compressive properties.

**UV (ULTRAVIOLET) STABILIZER** - Any chemical compound which, when added to thermoplastic material, selectively absorbs UV rays.

## v

**VACUUM METALIZING** - Process in which surfaces are thinly coated with metal by exposing them to the vapor of metal that has been evaporated under vacuum (one millionth of normal atmospheric pressure).

**VENT** - In a mold, a shallow channel or minute hole cut in the cavity to allow air to escape as the material enters.

**VENTURI DISPERSION PLUG** - See **BREAKER PLATE**.

**VERTICAL FLASH RING** - The clearance between the force plug and the vertical wall of the cavity in a positive or semi-positive mold; also the ring of excess material which escapes from the cavity into this clearance space.

**VICAT SOFTENING TEMPERATURE** - The temperature at which a plastic is penetrated to 1 mm depth by a flat-ended circular metal pin, while in a controlled (rate- - rise) temperature silicone fluid bath. (ASTM D 1525).

**VINYL** - Usually polyvinyl chloride, but may be used to identify other polyvinyl plastics.

**VIRGIN PLASTICS** or **VIRGIN MATERIAL** - Material not previously used or processed and meeting manufacturers specifications.

**VISCOSITY** - A measurement of resistance of a material to flow.

**VOID** - A void or bubble occurring in the center of a heave thermoplastic part usually caused by excessive shrinkage.

**VOLUME** - Synonym for **CAPACITY** or **DISPLACEMENT**.

**VOLUME RESISTIVITY** - The electrical resistance between opposite faces of a 1-cm. cube of insulating material. It is measured under prescribed conditions using a direct current potential after a specified time of electrification. It is commonly expressed in ohm-centimeters. Also called **SPECIFIC INSULATION RESISTANCE**. (ASTM D 257).

**VULCANIZATION** - A chemical reaction which induces extensive physical property changes in rubbers or elastomers, usually including cross linking and conversion of liquid or semi-solid to a solid.

## W

**WARPAGE** - Dimensional distortion in a plastic object after molding.

**WEB GATE** - See **DIAPHRAGM GATE**.

**WELD LINE** - See **FLOW LINE**.

**WELD MARK** - See **FLOW LINE**.

**WELDING** - Joining thermoplastic pieces by one of several heat-softening processes. Butt fusion, spin welding, ultrasonic, and hot gas are several methods.

**WHEELABRATING** - Deflashing molded parts by bombarding with small particles at a high velocity.

## Y

**YIELD VALUE** (Yield Strength) - (1) In tensile testing, the stress, usually in psi, at which there is no increase in stress with a corresponding increase in strain: Usually the first peak on the curve. (**YIELD POINT**) (2) The specific limiting deviation from the proportional **STRESS - STRAIN CURVE**.

**YOUNG'S MODULUS** - **MODULUS** of **ELASTICITY**

## Bibliography

The definitions listed here were compared with the following sources:

1. American National Standard, Appendix D, D2, Terms, *Engineering Drawing and Related Documentation Practices*. Dimensioning and Tolerancing. ANSI:Y14-5M. 1982.
2. ASTM, *Standard Abbreviations of Terms Relating to Plastics*, D-1600-86a, 1987.
3. ASTM, *Standard Definitions of Terms Relating to Plastics*, D-883-86b, 1987.
4. Beck, Ronald D., *Plastic Product Design*, VNR Co. Inc., NY, NY, 1980, 2nd ed., ISBN: 0-442-20632-1.
5. Bower, C. M. (EDITOR), *Composite Materials Glossary*, T/C Press, Los Angeles, CA, 1967. (Sponsored by DOD with Monsanto and Washington U-St. Louis, MO).
6. Frados, Joel, *Plastics Engineering Handbook of SPI, Glossary* (1-39), VNR Pbl. 1982.
7. Parker, Sybil P. (Editor), *Dictionary of Scientific and Technical Terms*, 4th, McGraw-Hill, NY 1989.
8. Phillips Petroleum, *Glossary of Plastics Terms* (Booklet), Bartelsville, OK, 1977.
9. Plastic Bottle Institute, *Good Practices Manual*, (Div. of SPI), Glossary, Sec. 7 p. 18-32.
10. Richardson, T. L., *Industrial Plastics, Theory and Practice*, Appendix A (Glossary), 1989.
11. Shah, Vishu, *Handbook of Plastics Testing Technology*, SPE (Wiley, NY, NY), 1984, ISBN: 0-471-07871-9.
12. SME, *Dictionary of Manufacturing Terms, Tool & Manufacturing Engineers Handbook*, 1987.
13. USI Chemicals, *Polyolefin Blow Molding: An Operating Manual*, 3rd Ed., 1986, Appendix B, (Blow Molding terms), p. 56-60.
14. Whittington, L. R., *Whittington's Dictionary of Plastics*, 2nd, Techmonic Publ., Westport, Ct., 1978.

### Reference Publications

#### A. General Information

Chanda, M., Roy, S.K., 1987. *Plastics Technology Handbook*. New York: Dekker Marcel.

Frados, Joel. 1976. *Plastics Engineering Handbook of The Society of the Plastics Industry*. 4th ed. New York: Van Nostrand Reinhold Publishing. ISBN:0-442-22469-9.

Frados, Joel. 1977. *The Story of the Plastics Industry*. New York: Society of the Plastics Industry. Out of Print.

Grandilli, P.A. 1981. *Technicians Handbook of Plastics*. New York: VNR. ISBN:0-442-23870-3.

Granvill, A.B. 1974. *Plastics Engineers Data Book*. 2nd ed. New York: Industrial Press. ISBN:0-8311-1105-4.

Hanser-Verlag, Carl. *Kunststoffe (German Plastics)*. Germany: Kobergerstrafe 22.

Jones, F.D., Horton, H.L. 1988. *Machinery's Handbook, Revised 23rd Edition*. Greenwich, CT: Society of Plastics Engineering. ISBN:0-8311-1200-X.

Kaufman, H.S., & J.J. Falcetta. 1977. *Introduction to Polymer Science and Technology*. Greenwich, CT: SPE. ISBN:0-471-01493-1.

Leidner, Jacob. 1981. *Plastics Waste: Recovery of Economic Value*. Greenwich, CT: SPE. ISBN:0-8247-1381-8.

Lubin, G. 1982. *Handbook of Composites*. Greenwich, CT: SPE. ISBN:0-442-24897-0.

Luce, Stu. 1988. *Introduction to Composites Technology*. 1st ed. Dearborn, MI: Society of Manufacturing Engineers.

McCrum, N.G., Buckley, C.P. 1988. *Principles of Polymer Engineering*. Dearborn, MI: SPE. ISBN:0-19-856152-0.

*Plastics, The World of Imagination*. VHS. Greenwich, CT: SPE.

Richardson, Terry A. 1989. *Industrial Plastics: Theory and Application*, 2nd Edition. Albany, NY: Delmar Publishers. ISBN:0-B273-3392-7.

Rosato, D.V. & D.V. Rosato. 1985. *Injection Molding Handbook*. Greenwich, CT: SPE. ISBN:0-442-27815-2.

Rubin, Irvin I. 1972. *Injection Molding, Theory and Practice*. New York: John Wiley and Sons. ISBN:0471-74445-X.

Saechtling, Hansjurgen. 1987. *International Plastics Handbook For The Technologist, Engineer and User, Second Edition*. Greenwich, CT: SPE. ISBN:0-02-949621-7.

Schwartz, S.S. & S.H. Goodman. 1982. *Plastics Materials and Processes*. New York: VNR. ISBN:0-42-22777-9 (Out of Print).

Strong, A. Brent. 1989. *Fundamentals of Composite Manufacturing: Materials, Methods, and Applications*. 1st ed. Dearborn, MI: SME.

*Modern Plastics*. New York: McGraw-Hill.

*Modern Plastics Encyclopedia*. New York: McGraw-Hill, Annual.

*Plastics Engineering*. Greenwich, CT: SPE.

*Plastics Technology*. New York.

*Recyclingplas III: Plastics Recycling*. The Plastics Institute of America and the U.S. Department of Energy, 1988.

*Recyclingplas IV: Plastics Recycling*. The Plastics Institute of America and the U.S. Department of Energy, 1989.

*Understanding Plastics*. VHS. BETA. Greenwich, CT: SPE.

### B. Materials

- Alper, Joseph & Gordon L. Nelson. 1989. *Polymeric Materials, Chemistry of the Future*. Washington, D.C.: American Chemical Society. ISBN:0-8412-1612-4.
- ASM International. 1988. *Engineering Plastics*. Greenwich, CT: SPE. ISBN:0-87170-280-0.
- Bernhardt, E.C. 1959. *Processing of Thermoplastic Materials*. Melbourne, FL: R.E. Kreiger. ISBN:0-88275-145-X.
- Bhowmick, A.K., Stephens, H.L. 1988. *Handbook of Elastomers: New Developments and Technology*. New York: Dekker Marcel. ISBN:0-824-7800-6.
- Birley, A.W., Heath, R.H., Scott, M.J. 1988. *Plastics Materials: Properties and Applications*, Second Edition. Greenwich, CT: SPE. ISBN:0-412-01781-4.
- Bittence, J.C. 1990. *Engineering Plastics and Composites*. Metals Park, OH: ASM Publications. ISBN:087170-369-6.
- Brandrup, J., Immergut, E.H. 1989. *Polymer Handbook, Third Edition*. New York: John Wiley. ISBN:0-471-81244-7.
- Brydson, J.A. 1989. *Plastic Materials*. Stoneham, ME: Butterworths. ISBN:0-408-00721-4.
- Courtney, Thomas H. 1990. *Mechanical Behavior of Materials*. New York: McGraw-Hill. ISBN:0-07-013265-8.
- Dyson, R.W. 1990. *Engineering Polymers*. New York: Blackie and Son/Chapman and Hall. ISBN:0-412-02081-5.
- Gachter, R. & H. Muller. 1987. *Plastics Additives*. Greenwich, CT: SPE. ISBN:0-02-94791-1.
- Hall, Christopher. 1989. *Polymer Materials, An Introduction For Technologists and Scientists, Second Edition*. Greenwich, CT: SPE. ISBN:0-470-21092-3.
- International Plastics Selector. *Thermoplastics and Thermosets Desk-top Data Bank, Annual*.
- Katz, H.S., Milewski, J.V. 1987. *Handbook of Fillers for Plastics*. Greenwich, CT: SPE. ISBN:0-442-26024-5.
- Legge, N.R., Holden, G., Schroeder, H.E. 1987. *Thermoplastic Elastomers*. Greenwich, CT: SPE. ISBN:0-19-52719-X.
- Lutz, John T. Jr. 1989. *Thermoplastic Polymer Additives*. Greenwich, CT: SPE. ISBN:0-8247-7901-0.
- MacDermott, Charles P. 1984. *Selecting Thermoplastics for Engineering Applications*. Greenwich, CT: SPE. ISBN:0-8247-7099-4.
- Margolis, James M. 1985. *Engineering Thermoplastics—Properties and Applications*. Greenwich, CT: SPE. ISBN:0-8247-7294-6.
- Meyer, Raymond W. 1985. *Handbook of Polyester Molding Compounds & Molding Technology*. Greenwich, CT: SPE. ISBN:0-412-00771-1.
- Modern Plastics Encyclopedia*. New York: McGraw-Hill, Annual.
- Oertel, Gunther. 1985. *Polyurethane Handbook*. Greenwich, CT: SPE. ISBN:3-446-1367-1.
- Plastics Edition I I Thermoplastics and Thermosets*. 1990. Greenwich, CT: SPE. ISBN:1041-0694.
- Rubin, Irvin I. 1988. *Handbook of Plastics Test Methods, 3rd Edition*. New York: Longman Scientifics & Technical, John Wiley. ISBN:0-582-03015-3.
- Seymour, Raymond B. 1987. *Polymers for Engineering Applications*. Metals Park, OH: ASM International. ISBN:087170-247-9.
- The Fundamentals of Plastics*. 1969. Greenwich, CT: SPE.
- The Resinkit™*. 1988. The Plastics Group.
- Walker, B.M. 1988. *Handbook of Thermoplastic Elastomers, Second Edition*. Greenwich, CT: SPE. ISBN:0-442-29184-1.

Webber, Thomas G. 1979. *Coloring of Plastics*. 1979. Greenwich, CT: SPE. ISBN:0-471-92327-3.

Young, Robert J. 1987. *Introduction to Polymers*. New York:Chapman and Hall. ISBN:0-412-22180-2.

### C. Quality Control and Testing

ASTM. *Standards 8.01, 8.02, 8.03, & 8.04*.

Brown, Roger P. 1988. *Handbook of Plastics Test Methods*. 3rd ed. New York: Longman Scientifics & Technical John Wiley. ISBN:0-582-08015-3.

*Polymer Characterization and Analysis*. ISBN:0-471-51325-3.

Shah, Vishu. 1984. *Handbook of Plastics Testing Technology*. SPE. New York: John Wiley. ISBN:0-471-07871-9.

Tobin, William J. 1986. *Quality Control for Plastics*. Greenwich, CT: SPE. ISBN:0-938648-26-8.

Tobin, William J. *Quality Control Manual for Injection Molding*. Greenwich, CT: SPE. ISBN:0-938648-13-6.

### D. Product Design

Beck, Ronald D. 1980. *Plastics Product Design, Second Edition*. Greenwich, CT: SPE. ISBN:0-442-20632-1.

Bernhardt, E. C. 1983. *CAE-Computer Aided Engineering for Injection Molding*. New York: MacMillian. ISBN:0-02-948590-8.

Brown, R.L.E. 1981. *Design and Manufacture of Plastic Parts*. New York: John Wiley. ISBN:0-471-05324-4.

Dym, J.B. 1983. *Product Design with Plastics*. Greenwich, CT: SPE. ISBN:0-8311-1141-0.

Ehrenstein, G.H. & G. Erhard. 1984. *Designing with Plastics*. Greenwich, CT: SPE. ISBN:0-02-948770-6.

Gaylord, M.W. 1974. *Reinforced Plastics*. 2nd ed. Newton, MA: Cahners. ISBN:0-8436-1210-X.

Levy, S. & J.H. Dubois. 1984. *Plastic Product Design Engineering Handbook, Second Edition*. Greenwich, CT: SPE. ISBN:0-412-00511-5.

Morton-Jones, D.H., Ellis, J.W. 1986. *Polymer Products: Design, Materials and Processing*. Greenwich, CT: SPE. ISBN:0-412-27130-3.

Wendle, B.C. 1976. *Engineering Guide to Structural Foam*. Lancaster, PA: Technomic. ISBN:0-87762-218-3.

West, G.H. 1986. *Engineering Design in Plastics*. CA: Kaiser Ed. ISBN:0-903107-39-2.

### E. Mold Design

Allyn, E.P. 1980. *Mold Design I*. Greenwich, CT: SPE.

Beall, Glenn L. 1988. *A Listing of Mold Making & Mold Design Teaching Institutions*. Greenwich, CT: SPE.

Bodini, G. Pessani, F. Cacchi. 1987. *Mould Machines and Moulds for Plastics Processing, Second Edition*. Greenwich, CT: SPE.

DuBois, J.H. & W.I. Pribble. 1987. *Plastic Mold Engineers Handbook*. 4th ed. Greenwich, CT: SPE. ISBN:0-442-21897-4.

Dym, Joseph B. 1987. *Injection Molds and Molding: A Practical Manual*. 2nd ed. Greenwich, CT: SPE. ISBN:0-442-21785-4.

Gastrow, Hans. 1983. *Injection Molds, 102 Proven Designs*. Greenwich, CT: SPE. ISBN:0-02-929440-0.

Glanvill, A.B. & E.N. Denton. 1965. *Injection Mould Design Fundamentals*. Greenwich, CT: SPE. ISBN:08311-1033-3.

I.T. Quanstrom Foundation. 1985. *Mold Finishing & Polishing Manual*. Greenwich, CT: SPE.

Manizione, Louis T. 1987. *Applications of Computer Aided Engineering In Injection Molding*. Greenwich, CT: SPE. ISBN:0-02-949541-1.

## Standards & Practices of Plastics Molders

## Reference Publications

Menges, G. & P. Mohren. 1986. *How To Make Injection Molds*. Greenwich, CT: SPE. ISBN:0-02-947570-8.

Morena, John J. 1988. *Advanced Composite Mold Making*. Greenwich, CT: SPE. ISBN:0-442-26414-3.

Morton-Jones, D.H. 1989. *Polymer Processing*. Greenwich, CT: SPE. ISBN:0-412-26700-4.

Pye, R.C.W. 1989. *Injection Mould Design*. 4th ed. New York: John Wiley. ISBN:0-470-21413-9.

Quanstrom (I.T.) Foundation. 1983. *Mold Making Reference Index*.

Sors, Laszio, Laszio Bardocz, & Istvan Radnoti. 1981. *Plastic Molds and Dies*. New York: VNR. ISBN:0-442-278899-6.

Stoeckert, Klaus. 1983. *Mold Making Handbook of The Society of the Plastics Industry*. Greenwich, CT: SPE. ISBN:0-02949670-5.

### F. Processing

Bikales, Norbert M. 1971. *Molding of Plastics*. New York: John Wiley. ISBN:0-471-07233-8.

Bown, John. 1979. *Industrial Moulding of Plastics Compounds*. New York: McGraw-Hill. ISBN:0-07-084521-2.

*Concepts of Polymer Processing*. 1967. ISBN:0-8169-0016-7.

deClair, Piaras V. 1985. *Polymers In Injection Molding*. Greenwich, CT: SPE. ISBN:0-938648-25-X.

*Injection Molding of Plastics (Conference/Discussion Record)*. 1980. Greenwich, CT: SPE. ISBN:0-938648-00-4.

*Injection Molding Video Program*. VHS. BETA. Greenwich, CT: SPE.

*Injection Molding Safety Video*. VHS. Greenwich, CT: SPE.

Isayev, Avraam I. 1987. *Injection and Compression Molding Fundamentals*. Greenwich, CT: SPE. ISBN:0-8247-7670-4.

Johannabar, F. 1983. *Injection Molding Machines*. Greenwich, CT: SPE. ISBN:0-02-949420-6.

Macosko, Christopher W. 1988. *Fundamentals of Reaction Injection Molding*. Greenwich, CT: SPE. ISBN:0-19-520759-9.

Manziona, Louis T. 1987. *Applications of Computer Aided Engineering In Injection Molding*. Greenwich, CT: SPE. ISBN:0-02-949541-1.

Margolis, James M. 1988. *Instrumentation For Thermoplastics Processing*. Greenwich, CT: SPE. ISBN:0-19-520768-8.

Morton-Jones, D. H. 1989. *Polymer Processing*. New York: Chapman and Hall. ISBN:0-412-26690-3.

Rosato, D.V. 1989. *Blow Molding Handbook*. Greenwich, CT: SPE. ISBN:0-19-520761-0.

Rosato, D.V. 1985. *Injection Molding Handbook*. Greenwich, CT: SPE. ISBN:0-442-27815-2.

Rosato, D. V. 1990. *Plastics Processing Data Handbook*. Greenwich, CT: SPE. ISBN:0-442-31869-3.

Rubin, Irvin I. 1972. *Injection Molding—Theory and Practice*. Greenwich, CT: SPE. ISBN:0-471-74445-X.

Tadmor, Z., Gogos, C.G. 1979. *Principles of Polymer Processing*. Greenwich, CT: SPE. ISBN:0-471-84320-2.

Tucker, Charles L. III. 1989. *Computer Modeling For Polymer Processing*. Greenwich, CT: SPE. ISBN:0-19-52076615.

Tucker, Charles L. III. 1989. *Fundamentals of Computer Modeling For Polymer Processing*. Greenwich, CT: SPE. ISBN:0-5207561.

WJT Associates. 1988. *Basic Injection Molding and Troubleshooting*. Greenwich, CT: SPE.

Weir, Clifford L. 1975. *Introduction To Injection Molding*. Greenwich, CT: SPE.

---

## Standards & Practices of Plastics Molders

---

## Reference Publications

### G. Fabrication, Assembly, Painting, and Decorating

Margolis, James M. 1986. *Decorating Plastics*. Greenwich, CT: SPE. ISBN:0-02-947580-5.

Satos, Don. 1986. *Plastics Finishing and Decorating*. Greenwich, CT: SPE. ISBN:0-442-28062-9.

### H. Publishers and Organizations

Dekker Marcel, Inc.  
270 Madison Ave.  
New York, NY 10016

VNR Publishing (Van Norstand Reinhold)  
115-T 5th Ave.  
New York, NY 10003

The Society of the Plastics Industry (SPI)  
1801 K Street, N.W., Suite 600K  
Washington, DC 20006-1301

Industrial Press, Inc.  
200 Madison Ave.  
New York, NY 10157

Kobergerstraße 22  
8 Munchen 27, Germany

SPE (Society of Plastics Engineering)  
14 Fairfield Drive  
Brookfield, CT 06804

SME (Society of Manufacturing Engineers)  
One SME Dr.  
P.O. Drawer 930  
Dearborn, MI 48121

Delmar Publishers, Inc.  
Two Computer Drive W  
Box 15-015  
Albany, NY 12212

McGraw-Hill  
1221 Avenue of the Americas  
New York, NY 10020

The Plastics Institute of America  
Stevens Institute of Technology  
Castle Point Station  
Hoboken, NJ 07030

The US Department of Energy  
Forrestal Building  
1000 Independence Ave S.W.  
Washington, DC 20585

ACS (American Chemical Society)  
1155-T 16th St. NW  
Washington, DC 20036

R.E. Kreiger Publishing Co., Inc.  
P.O. Box 9542  
Melbourne, FL 32902

ASM International  
Metals Park, OH 44073

John Wiley & Sons, Inc.  
605 Third Ave.  
New York, NY 10158

Butterworths Publishing Co.  
80 Montvale  
Stoneham, ME 02180

MacMillan, Inc.  
866-T 3rd Ave.  
New York, NY 10022

Cahners Publishing Co.  
275-T Washington St.  
Newton, MA 02158

Technomic Publishing Co., Inc.  
P.O. Box 3535  
851 Holland Avenue  
Lancaster, PA 17604



---

<b>Standards &amp; Practices of Plastics Molders</b>	<b>Reference Publications</b>
--	-----------------------------------

---

